

INSTALLATION INSTRUCTION SUPPLEMENT - CUSTOM CHASE TOPS and SHROUDS

CUSTOM CHASE TOPS

As an alternative to using Model UTL/GTL, Part # UTL-TF, on chase top installations, it is permissible to substitute a non-Selkirk, metal chase cover if the guidelines shown below are followed.

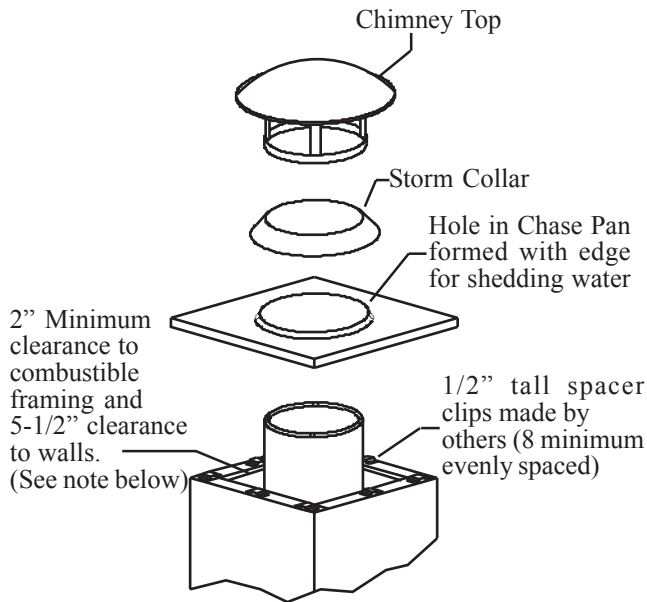

2" Minimum clearance to combustible framing and 5-1/2" clearance to walls. (See note below)

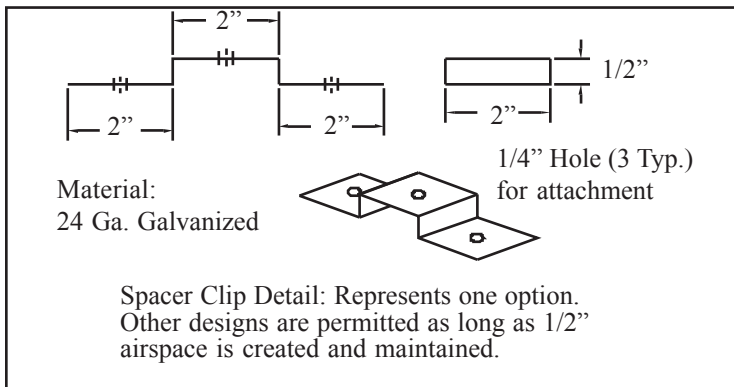
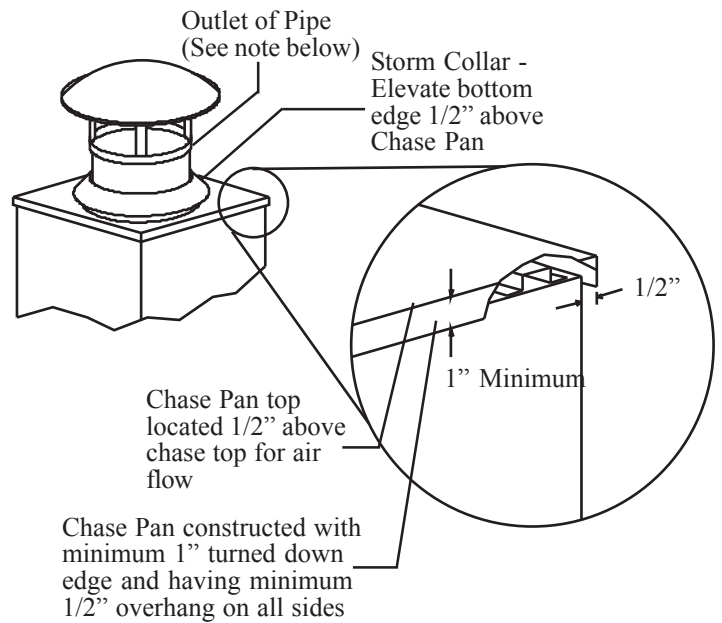

NOTE: Chimney outlet to extend a **MINIMUM 6"** above Chase Pan. **2" MINIMUM** clearance is to framing only. There must be a **MINIMUM 5-1/2"** clearance to walls.



⚠ WARNING

Failure to follow the installation instructions could cause **FIRE, CARBON MONOXIDE POISONING, OR DEATH.** If you are unsure of installation requirements, call the Phone Number listed on the instructions or visit www.selkirkcorp.com

SHROUDS

In some areas, chimneys are permitted to be installed with a decorative shroud surrounding the standard termination cap. There are three styles of shrouds that are now permissible to use with SCS Chimney systems. They are referred to as Pyramid, Mailbox, and House styles. Each individual style has its own set of criteria. Below are the guidelines to all three styles.

NOTES:

1. All Shrouds must be constructed of stainless steel, aluminum steel or copper. Non-metallic materials - such as brick, stone, clay products, stucco, etc., may also be used if they are 100% non-combustible, can withstand the surrounding environment (exposure to heat, cold, rain, ice, snow, UV, etc.) and are approved by the local authority having jurisdiction.
2. Sides of shrouds (all styles) may be vertical, sloped or curved if desired, as long as indicated minimum openings are maintained.
3. In all instances a minimum of 6" of chimney must extend above the base of the Flashing/Chase cover before attaching Cap.
4. Multiple smaller openings are permitted where single larger openings are shown if minimum total open area is maintained for each.
5. Given dimensions are for a single chimney system only. Combine the required open area for each chimney system to get the minimum required total for multiple systems.

Mailbox Style Shroud

Dia	Cap Style/Dome OD	H (in.) Minimum	W (in.) Minimum
5	CT / 10	12	11
6	CT / 12	12	13
7	CT / 14	13	15
8	CT / 16	13	17
10	CT / 20	15	21
10	EZ / 16	17	17
12	CT / 24	17	25
12	EZ / 20	19	21
14	CT / 28	18	29
14	EZ / 20	19	21
16	EZ / 24	21	25
18	EZ / 24	21	25
20	EZ / 28	26	29
22	EZ / 32	28	33
24	EZ / 32	28	33

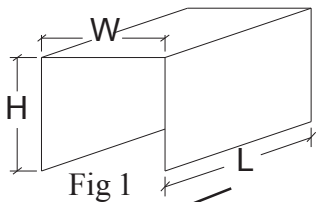

Dashed lines represent minimum dimensional design and open area (from Fig 1.) that must be present when constructing shroud. (See Fig 1)

L = (Shroud Length) Must not extend past the cap dome more than 1-1/2 times the dome diameter for sizes 5" thru 10" and 1 times the dome diameter for sizes 12" thru 24" at either end.

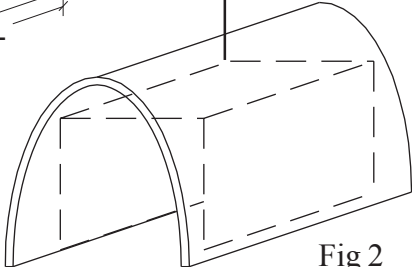

Fig 2

House Style Shroud

Dia	Cap Style/Dome OD	H (in.)	W (in.)	L (in.)	Minimum open area for single side (sq. in.) *
5	CT / 10	12	11	11	20
6	CT / 12	12	13	13	28
7	CT / 14	13	15	15	39
8	CT / 16	13	17	17	50
10	CT / 20	15	21	21	79
10	EZ / 16	17	17	17	79
12	CT / 24	17	25	25	113
12	EZ / 20	19	21	21	113
14	CT / 28	18	29	29	154
14	EZ / 20	19	21	21	154
16	EZ / 24	21	25	25	201
18	EZ / 24	21	25	25	254
20	EZ / 28	26	29	29	314
22	EZ / 32	28	33	33	380
24	EZ / 32	28	33	33	452

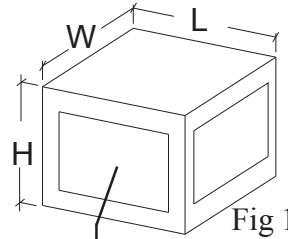

Fig 1

Dashed lines represent minimum dimensional design and open area (from Fig 1.) that must be present when constructing shroud. (See Fig 1)

Must be a minimum of open area on all four sides of shroud. Multiple openings are permitted on each side if minimum total open area is maintained for each (See Chart).

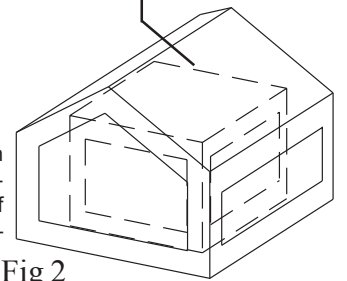

Fig 2

Pyramid Style Shroud

Dia.	Cap Style/Dome OD	W (in.) Minimum	L (in.) Minimum	a x b = Minimum open area at bottom of each side (sq. in.)
5	CT / 10	13	13	4.91
6	CT / 12	15	15	7.10
7	CT / 14	17	17	9.65
8	CT / 16	19	19	12.60
10	CT / 20	22	22	19.65
10	EZ / 16	21	21	19.65
12	CT / 24	26	26	28.30
12	EZ / 20	23	23	28.30
14	CT / 28	31	31	38.50
14	EZ / 20	25	25	38.50
16	EZ / 24	30	30	50.30
18	EZ / 24	31	31	63.65
20	EZ / 28	36	36	78.55
22	EZ / 32	37	37	95.10
24	EZ / 32	39	39	113.10

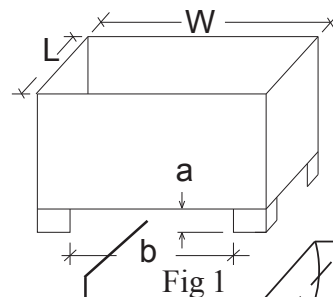

Fig 1

Dashed lines represent minimum dimensional design and open area (from Fig 1.) that must be present when constructing shroud. (See Fig 1)

Minimum open area at bottom of shroud on each side (see chart)

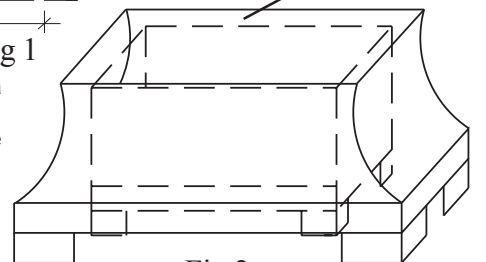

Fig 2