

PRODUCT CATALOGUE

— RIGID/FLEXIBLE — **VERSA-LINER™** STAINLESS STEEL CHIMNEY LINER

5" to 8" Diameter



WOOD



GAS



OIL



COAL



CORN, WHEAT and
other BIO-FUELS

Listed To: ULC-S635, ULC-S640 and UL 1777

Get the Selkirk® Advantage...

The tradition continues... Selkirk is the original innovator of prefabricated Venting systems - and we continue to move forward. Count on Selkirk, the world's most recognizable name in Chimney & Venting, for the widest range of high-performance products to meet your needs.



Versa-Liner Stainless Steel Chimney for Wood, Oil, Gas or Coal Appliances

Versa Liner is the most versatile Stainless Steel Chimney re-lining system on the market. It can be used as either a RIGID or FLEX chimney liner system or in combination as required.

- Use the same component parts with either Rigid or Flex
- Use Versa-Liner FLEXIBLE Lengths where offsets are required
- Use Versa-Liner RIGID Lengths inside straight chimneys
- Available in Kits, or individual component parts
- Optional one-piece Insulation Blanket allows you to wrap the liner system where required or desired
- Selkirk Round Top termination attaches without screws
- Stainless Flashing with 24 x 24 base
- Swivel Tee with 14" snout

Versa-Liner Specifications

- Rigid Liner Material - 0.016 Type 304 Stainless Steel
- Flex Liner Material - 316L Stainless Steel
- Available in 5", 6", 7" and 8" diameters
- 4" Flex Kits available as special order
- Standard Flex Kit Lengths - 25' and 35'
- Clearances - 0" between liner and masonry chimney interior
- Insulation - Wraps available in 10' lengths
- Listed To ULC-S635, ULC-S640 in Canada and UL 1777 in USA
- "Smart Choice" Lifetime Warranty

Typical Installations

Rigid Liner Installation with Offset

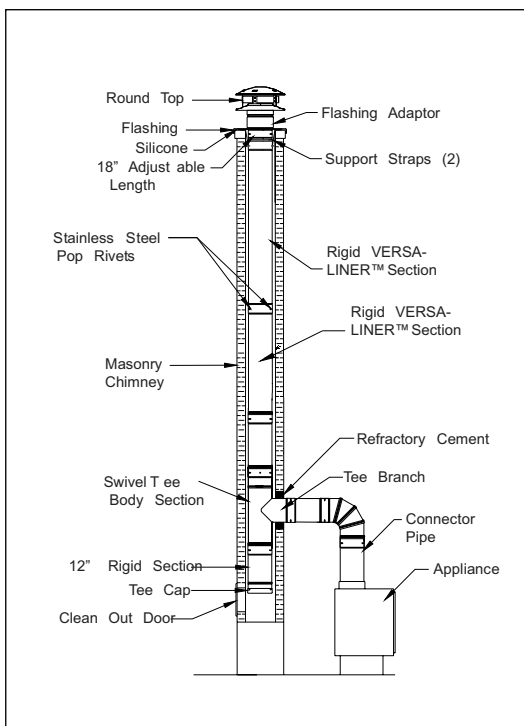

VERSA-LINER is designed for installation in new and existing masonry chimneys. In some applications, offsets may be required.

Rigid/Flex Liner Installation

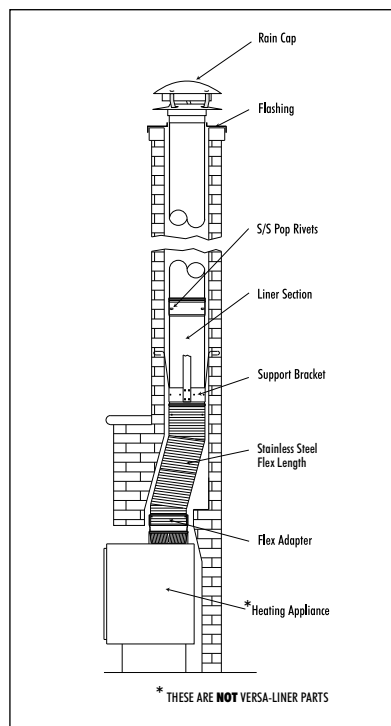

In the above diagram, where the appliance is installed below a masonry chimney, a flex connector is a convenient component for confined spaces.

Flex Liner Installation

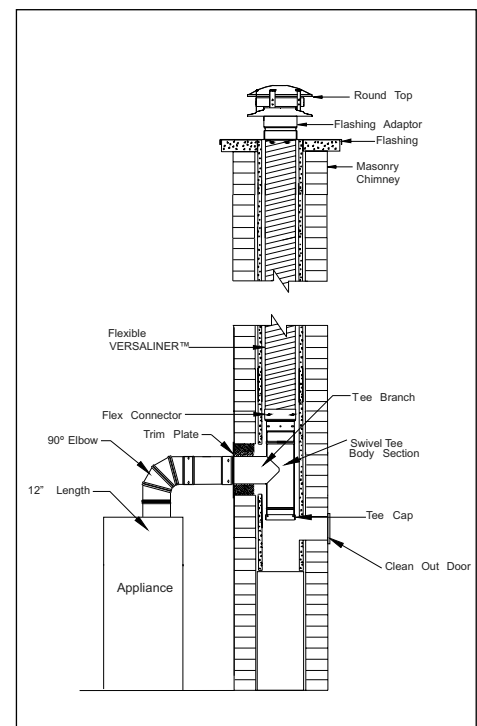

In the above diagram, an oil heating appliance has been vented using a Versa-Liner flex system.

Versa-Liner Stainless Steel Chimney for Wood, Oil, Gas or Coal Appliances

Kits

Complete Flex Kit



- Install the CompleteFlex Kit where a Tee is required for connection between Versa-Liner Stainless Steel Flex in the vertical position and the appropriate connector pipe in the horizontal position
- Use of a Tee is required by Installation Code B139 for re-lining Masonry chimneys in Oil applications
- Includes Flex Liner, Rain Cap, Flashing, Flashing Adaptor, Flex Connector, Tee w/cap

SIZE	PRODUCT CODE	PART #	PACK
4" 25'	1748133	SF4-25K	1
4" 35'	1748155	SF4-35K	1
5" 25'	1758133	5RF25KT	1
5" 35'	1758155	5RF35KT	1
6" 25'	1768133	6RF25KT	1
6" 35'	1768155	6RF35KT	1
7" 25'	1778133	7RF25KT	1
7" 35'	1778155	7RF35KT	1
8" 25'	1788133	8RF25KT	1
8" 35'	1788155	8RF35KT	1

Insert Flex Kit



- Install the Insert Flex Kit where the Versa-Liner Stainless Steel Flex Liner is connected to the flue outlet of the appliance. A Flex Connector is included to adapt each Liner inner diameter to a 6" flue outlet
- Includes Flex Liner, Rain Cap, Flashing, Flashing Adaptor, 6" Appliance Adaptor

SIZE	DIMENSIONS	PRODUCT CODE	PART #	PACK
5"	25'	1758134	5RF25IK	1
5"	35'	1758156	5RF35IK	1
5.5"	25'	1759134	55RF25IK	1
5.5"	35'	1759155	55RF35IK	1
6"	25'	1768134	6RF25IK	1
6"	35'	1768156	6RF35IK	1

Starter Kit



- Use the Starter Kit where the Versa-Liner Stainless Steel Flex Liner Lengths and Components Parts are purchased separately. Starter Kits contain a Tee w/Cap for connection between Versa-Liner Stainless Steel Flex in the vertical position and the appropriate connector pipe in the horizontal position
- Includes Rain Cap, Flashing, Flashing Adaptor, Flex Connector, Tee w/Cap and Adjustable Length

SIZE	PRODUCT CODE	PART #	PACK
4"	1748165	SF4-SK	1
5"	195165	5RFSK	1
6"	196165	6RFSK	1
7"	197165	7RFSK	1
8"	198165	8RFSK	1

Insulation Wrap Kit



- 10 ft. Kit includes foil-backed insulation, wire mesh, stainless steel ties and aluminum tape
- Used for both Flexible and Rigid Versa Liner
- Reduces heat loss to maintain high flue temperatures
- A requirement for UL 1771 - allows for reduced clearance to combustibles (see installation instructions for details)

SIZE	PRODUCT CODE	PART #	PACK
5"	195120	5RF10I	1
6"	196120	6RF10I	1
7"	197120	7RF10I	1
8"	198120	8RF10I	1

Versa-Liner Stainless Steel Chimney for Wood, Oil, Gas or Coal Appliances

Parts & Accessories

Rigid Pipe Length

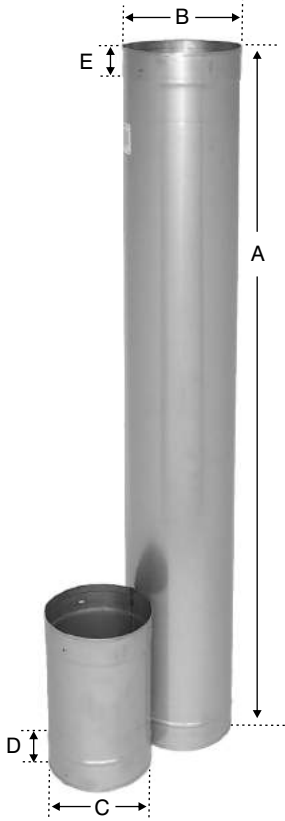

- Lengths are 304 Stainless Steel
- Available in Lengths of 6", 12", 24", 36" and 48"
- Available in diameters of 5", 6", 7" and 8"
- Three rivets per Length

SIZE	DIMENSIONS					PRODUCT CODE	PART #	PACK
	A	B	C	D	E			
5"	48"	5"	4-7/8"	2"	2-1/8"	195048	5RF48	4
6"	48"	6"	5-7/8"	2"	2-1/8"	196048	6RF48	4
7"	48"	7"	6-7/8"	2"	2-1/8"	197048	7RF48	4
8"	48"	8"	7-7/8"	2"	2-1/8"	198048	8RF48	4

SIZE	DIMENSIONS					PRODUCT CODE	PART #	PACK
	A	B	C	D	E			
5"	36"	5"	4-7/8"	2"	2-1/8"	195036	5RF36	4
6"	36"	6"	5-7/8"	2"	2-1/8"	196036	6RF36	4
7"	36"	7"	6-7/8"	2"	2-1/8"	197036	7RF36	4
8"	36"	8"	7-7/8"	2"	2-1/8"	198036	8RF36	4

SIZE	DIMENSIONS					PRODUCT CODE	PART #	PACK
	A	B	C	D	E			
5"	24"	5"	4-7/8"	2"	2-1/8"	195024	5RF24	1
6"	24"	6"	5-7/8"	2"	2-1/8"	196024	6RF24	1
7"	24"	7"	6-7/8"	2"	2-1/8"	197024	7RF24	1
8"	24"	8"	7-7/8"	2"	2-1/8"	198024	8RF24	1

SIZE	DIMENSIONS					PRODUCT CODE	PART #	PACK
	A	B	C	D	E			
5"	12"	5"	4-7/8"	2"	2-1/8"	195012	5RF12	1
6"	12"	6"	5-7/8"	2"	2-1/8"	196012	6RF12	1
7"	12"	7"	6-7/8"	2"	2-1/8"	197012	7RF12	1
8"	12"	8"	7-7/8"	2"	2-1/8"	198012	8RF12	1

SIZE	DIMENSIONS					PRODUCT CODE	PART #	PACK
	A	B	C	D	E			
5"	6"	5"	4-7/8"	2"	2-1/8"	195006	5RF6	1
6"	6"	6"	5-7/8"	2"	2-1/8"	196006	6RF6	1
7"	6"	7"	6-7/8"	2"	2-1/8"	197006	7RF6	1
8"	6"	8"	7-7/8"	2"	2-1/8"	198006	8RF6	1

Rigid Adjustable Length

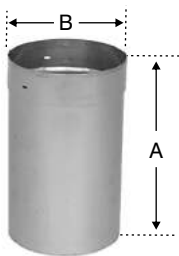

- Used to adjust the liner to the required length
- Adjustable from 4-1/2" to 14"

SIZE	DIMENSIONS		PRODUCT CODE	PART #	PACK
	A	B			
5"	18"	5"	195084	5RFAL	1
6"	18"	6"	196084	6RFAL	1
7"	18"	7"	197084	7RFAL	1
8"	18"	8"	198084	8RFAL	1

Versa-Liner Stainless Steel Chimney for Wood, Oil, Gas or Coal Appliances

Parts & Accessories

Flex Lengths



- Use the Flex Lengths where the Stainless Steel Flex Liner Lengths and Component Parts are purchased separately
- Flex lengths are packaged in 25' Coils in 5", 6", 7" and 8" diameters
- Lengths are also available in 35' Coils in 5", and 6" diameters

SIZE	DIMENSIONS		PRODUCT CODE	PART #	PACK
Length					
4"	25'		1748355	SF4-35L	1
5"	25'		1758255	5RF25FL	1
5"	35'		1758355	5RF35FL	1
6"	25'		1768255	6RF25FL	1
6"	35'		1768355	6RF35FL	1
7"	25'		1778255	7RF25FL	1
8"	25'		1788255	8RF25FL	1

45 Degree Elbow

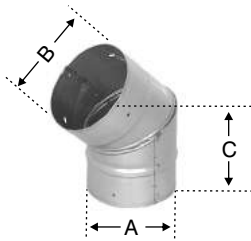

- Use in an offset installation

SIZE	DIMENSIONS			PRODUCT CODE	PART #	PACK
	A	B	C			
5"	4-7/8"	5"	7-15/16"	195215	5RF45	1
6"	5-7/8"	6"	8-3/8"	196215	6RF45	1
7"	6-7/8"	7"	8-5/8"	197215	7RF45	1
8"	7-7/8"	8"	9-1/16"	198215	8RF45	1

90 Degree Elbow

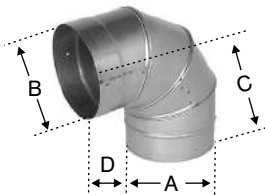

- Use in an offset installation

SIZE	DIMENSIONS				PRODUCT CODE	PART #	PACK
	A	B	C	D			
5"	4-7/8"	5"	6-3/4"	6-3/8"	195230	5RF90	1
6"	5-7/8"	6"	7-3/8"	6-3/4"	196230	6RF90	1
7"	6-7/8"	7"	7-3/4"	7-3/8"	197230	7RF90	1
8"	7-7/8"	8"	8-3/8"	7-3/4"	198230	8RF90	1

Tee Section with Cap

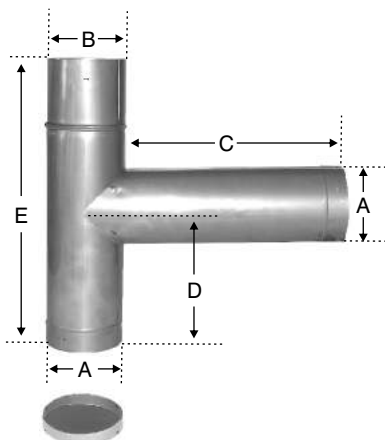

- 2 piece design for easy installation into a masonry chimney
- Built-in swivel for ease of installation
- Comes complete with Tee Cap
- Tee branch may be cut to size where required

SIZE	DIMENSIONS					PRODUCT CODE	PART #	PACK
	A	B	C	D	E			
5"	4-7/8"	5"	14"	9"	18"	195100	5RFTE	1
6"	5-7/8"	6"	14"	9"	18"	196100	6RFTE	1
7"	6-7/8"	7"	14"	9"	18"	197100	7RFTE	1
8"	7-7/8"	8"	14"	9"	18"	198100	8RFTE	1

Versa-Liner Stainless Steel Chimney for Wood, Oil, Gas or Coal Appliances

Parts & Accessories

Flashing

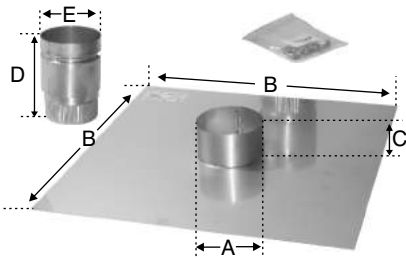

- Used

SIZE	DIMENSIONS					PRODUCT CODE	PART #	PACK
	A	B	C	D	E			
5"	5-3/8"					195850	5RFFA	1
6"	6-3/8"					196850	6RFFA	1
7"	7-3/8"					197850	7RFFA	1
8"	8-3/8"					198850	8RFFA	1

Flashing

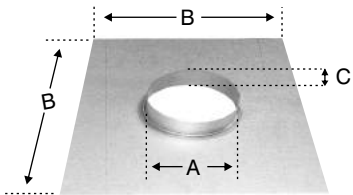

- Used at the top of the masonry chimney

SIZE	DIMENSIONS			PRODUCT CODE	PART #	PACK
	A	B	C			
5"	5-3/8"	24"	3"	195815	5RF5F	1
6"	6-3/8"	24"	3"	196815	6RF5F	1
7"	7-3/8"	24"	3"	197815	7RF5F	1
8"	8-3/8"	24"	3"	198815	8RF5F	1

Round Top

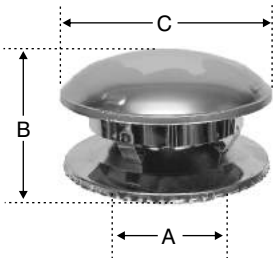

- Advanced design, premium quality stainless steel
- Provides protection against precipitation and creates a venturi effect to enhance draught
- Secured in position with stainless steel screws providing easy removal for inspection and cleaning

SIZE	DIMENSIONS			PRODUCT CODE	PART #	PACK
	A	B	C			
5"	4-7/8"	7-3/4"	10"	195800	5RFRT	1
6"	5-7/8"	8-1/2"	12"	196800	6RFRT	1
7"	6-7/8"	9-1/8"	14"	197800	7RFRT	1
8"	7-7/8"	10"	16"	198800	8RFRT	1

DIKAPT (Anti Downdraft Cap)

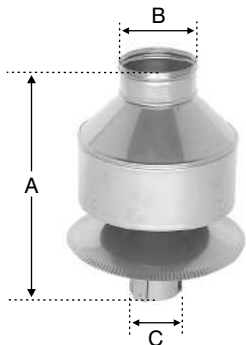

- Provides protection from wind and rain during cold chimney conditions
- Ensures normal flow of hot gases during windy conditions
- Constructed of 300 Series Stainless Steel

SIZE	DIMENSIONS			PRODUCT CODE	PART #	PACK
	A	B	C			
5"	17-1/4"	6"	4-3/4"	195802	5RFDK	1
6"	19-1/4"	7"	5-3/4"	196802	6RFDK	1
7"	19-1/4"	8"	6-3/4"	197802	7RFDK	1
8"	19-1/4"	9"	7-3/4"	198802	8RFDK	1

Flex Connector

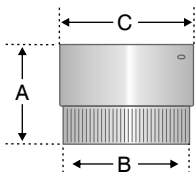

- Fitting used for joining Versa-Liner lengths
- Crimped for ease of assembly

SIZE	DIMENSIONS		PRODUCT CODE	PART #	PACK
	A	B			
4"	4"	3.97"	174060	SF4-FC	1
5"	4"	4.97"	175060	5RFFC	1
6"	4"	5.97"	176060	6RFFC	1
7"	4"	6.97"	177060	7RFFC	1
8"	4"	7.97"	178060	8RFFC	1

Versa-Liner Stainless Steel Chimney for Wood, Oil, Gas or Coal Appliances

Parts & Accessories

5" Flex to 6" Stove Adaptor

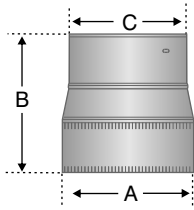

- Provides transition from a 6" appliance outlet to a 5" diameter Flex Liner
- Crimped for ease of assembly

SIZE	DIMENSIONS			PRODUCT CODE	PART #	PACK
	A	B	C			
5" to 6"	6"	6-1/4"	5"	175230	5RF6SA	1

Increaser



- To increase liner to a larger diameter

SIZE	DIMENSIONS			PRODUCT CODE	PART #	PACK
	A	B	C			
5" to 6"	9-3/8"	6"	4-7/8"	195306	5RF6I	1
6" to 7"	9-3/8"	7"	5-7/8"	196307	6RF7I	1
7" to 8"	9-3/8"	8"	6-7/8"	197308	7RF8I	1

Reducer



- To reduce liner to a smaller diameter

SIZE	DIMENSIONS			PRODUCT CODE	PART #	PACK
	A	B	C			
6" to 5"	9-3/8"	5"	5-7/8"	196365	6RF5R	1
7" to 6"	9-3/8"	6"	6-7/8"	197366	7RF6R	1
8" to 7"	9-3/8"	7"	7-7/8"	198367	8RF7R	1

Trim Plate

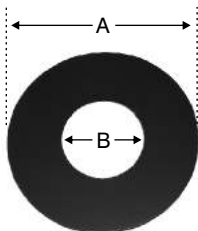

- Matte black finish provides a decorative finish to installation.
- Has four holes with black screws for mounting

SIZE	DIMENSIONS		PRODUCT CODE	PART #	PACK
	A	B			
5"	12"	5-1/8"	195500	5RFTP	1
6"	12"	6-1/8"	196500	6RFTP	1
7"	14"	7-1/8"	197500	7RFTP	1
8"	14"	8-1/8"	198500	8RFTP	1

Support Bracket

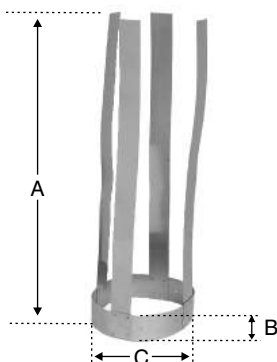

- Additional support for liner, also used above each offset
- Used only with rigid components

SIZE	DIMENSIONS			PRODUCT CODE	PART #	PACK
	A	B	C			
5"	22"	2"	5"	195200	SL5SB	1
6"	22"	2"	6"	196200	SL6SB	1
7"	22"	2"	7"	197200	SL7SB	1
8"	22"	2"	8"	198200	SL8SB	1



The Best Warranty in the Industry

Versa-Liner features advanced engineering designs and premium materials which allow us to offer a Lifetime Warranty.

See written warranty for details.

All Hearth Products Are Not Created Equal.



Flexible Aluminum Chimney Liners



Stainless Steel Chimney Liners



Pellet-Pipe



Insulated Chimney Systems



Stove Pipe



**Direct Vent Pipe
for Gas, Pellet, or Multi Fuel**



Reduce, Reuse, Recycle
Our literature is printed on
recyclable paper



Selkirk Corporation
5030 Corporate Exchange Blvd. SE
Grand Rapids, MI 49512
Toll Free: 1.800.433.6341
info@selkirkcorp.com

www.selkirkcorp.com

Selkirk Canada Corporation
375 Green Road
Stoney Creek, ON L8E 4A5
Toll Free: 1.888.SELKIRK (735-5475)
info@selkirkcanada.com