



Ultimate StovePipe™

All-Fuel, Double Wall Chimney Connector System
US and CANADA



TABLE OF CONTENTS

Typical Installations For Model USP	3
Introduction/Construction Features	4
Lengths.....	5
Telescopic Lengths	5
Adjustable Lengths.....	6
Finishing Bands	6
30° Elbows.....	7
45° Elbows.....	7
90° Elbows	7
Tees.....	8
Masonry Adapters.....	8
Increases.....	8
Reducers	9
Low Profile Stove Adapters.....	9
Jotul Stove Adapter	9
Oval-To-Round Adapters.....	10
In-Line Dampers.....	10
Elbow Offset Charts.....	11

Typical Installations

MASONRY INSTALLATION



CLEANOUT INSTALLATION



STRAIGHT-UP INSTALLATION



THROUGH THE WALL INSTALLATION



Ultimate StovePipe

MODEL USP DOUBLE-WALL STOVEPIPE

Ultimate StovePipe is designed to provide optimal wood stove performance and has a sleek, smooth, clean-look to compliment any stove and home.

Double wall stovepipe is the best choice to connect a freestanding stove to a chimney system. In comparison to single wall stove pipe, it offers:

- Reduced & enhanced clearance to combustible materials, 6" versus 18"
- Reduces creosote formation
- Enhances Draft

FEATURES

- Smooth, clean appearance on all components - pipe lengths, elbows and tees - to compliment any stove & home interior
- Sleek, smooth, clean-looking welded seams on inner and outer
- Satin coat steel 0.018" outer casing specifically designed for optimum paint adhesion and scratch resistance
- Stainless steel inner liner warms quickly, holds the heat in and improves efficiency
- Air-insulated, double wall design - approximately 7/16" air space
 - Provides better insulation & heat retention
 - Allows flue to warm up quickly to establish strong draft
 - Reduces moisture to minimize creosote build-up & minimize maintenance
- Joints secured with screws for easy assembly and inspection
- Pre-drilled pilot holes for fast installation
- Faster start-ups lead to less smoke & less pollution in the environment
- Maintains higher flue-gas temperatures
- Results in lower outer surface temperature
- Easily fits most stoves, including cast iron stoves and stoves with oval collars
- Drip-free design to prevent creosote leakage
- Components individually packed
- Duravent Group Limited Lifetime Warranty



CERTIFICATION

- Tested & certified to CAN/ULC-641 (Canada) and temperature requirements of UL 103 TYPE HT (USA)
- 6" clearance to combustibles in all diameters - even when installed in a corner, or parallel with a ceiling
- NOTE - Always consult the stove manufacturer's installation instructions for installation requirements



Forrest Stove Bright Metallic
Black
#6309

- 6", 7", and 8" diameters
- 6", 12", 18", 24", 36", and 48" lengths
- Easy to install and disassemble
- Hardware pack included

LENGTHS

Size	Product Number	Part Number	A	B	C	D
6"	276006	6USP-L6	6"	6 7/8"	6"	4 5/8"
6"	276012	6USP-L12	6"	6 7/8"	12"	10 5/8"
6"	276018	6USP-L18	6"	6 7/8"	18"	16 5/8"
6"	276024	6USP-L24	6"	6 7/8"	24"	22 5/8"
6"	276036	6USP-L36	6"	6 7/8"	36"	34 5/8"
6"	276048	6USP-L48	6"	6 7/8"	48"	46 5/8"
7"	277006	7USP-L6	7"	7 7/8"	6"	4 5/8"
7"	277012	7USP-L12	7"	7 7/8"	12"	10 5/8"
7"	277018	7USP-L18	7"	7 7/8"	18"	16 5/8"
7"	277024	7USP-L24	7"	7 7/8"	24"	22 5/8"
7"	277036	7USP-L36	7"	7 7/8"	36"	34 5/8"
7"	277048	7USP-L48	7"	7 7/8"	48"	46 5/8"
8"	278006	8USP-L6	8"	8 7/8"	6"	4 5/8"
8"	278012	8USP-L12	8"	8 7/8"	12"	10 5/8"
8"	278018	8USP-L18	8"	8 7/8"	18"	16 5/8"
8"	278024	8USP-L24	8"	8 7/8"	24"	22 5/8"
8"	278036	8USP-L36	8"	8 7/8"	36"	34 5/8"
8"	278048	8USP-L48	8"	8 7/8"	48"	46 5/8"

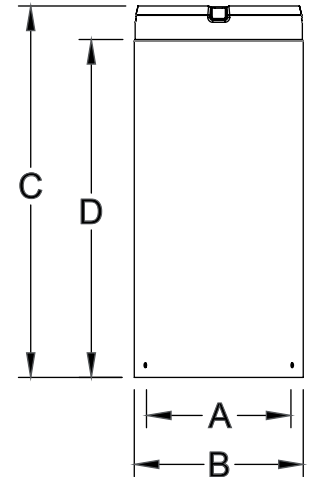

- 6", 7", and 8" diameters
- Two-piece telescoping section comprised of (1) 36" Length and (1) 36" Adjustable Length
- Provides installation flexibility from stove to the chimney system
- Wide Finishing Band included
- Hardware pack included

TELESCOPIC LENGTHS

Size	Product Number	Part Number	A	B	C MIN	C MAX	D MIN	D MAX
6"	276066	6USP-TL	6"	6 7/8"	39 1/4"	72"	35 3/4"	68 1/2"
7"	277066	7USP-TL	7"	7 7/8"				
8"	278066	8USP-TL	8"	8 7/8"				

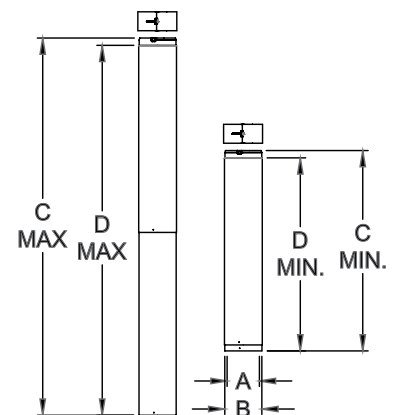

ADJUSTABLE LENGTHS

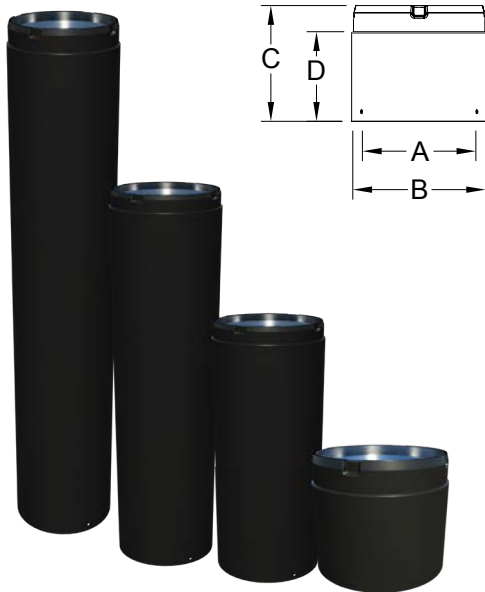

- 6", 7", and 8" diameters
- 6", 12", 18" and 36" adjustable lengths
- Adjustable Lengths slide over any regular length for installation flexibility
- Adjustable Lengths may be used as a Stove Adapter
- Use in a vertical and/or horizontal installation
- Hardware pack included

Size	Product Number	Part Number	A	B	C	D (MIN)	D (MAX)
6"	276004	6USP-AL6	6"	6 7/8"	6"	2"	4"
6"	276010	6USP-AL12	6"	6 7/8"	12"	2"	10"
6"	276016	6USP-AL18	6"	6 7/8"	18"	2"	16"
6"	276034	6USP-AL36	6"	6 7/8"	36"	2"	34"
7"	277004	7USP-AL6	7"	7 7/8"	6"	2"	4"
7"	277010	7USP-AL12	7"	7 7/8"	12"	2"	10"
7"	277016	7USP-AL18	7"	7 7/8"	18"	2"	16"
7"	277034	7USP-AL36	7"	7 7/8"	36"	2"	34"
8"	278004	8USP-AL6	8"	8 7/8"	6"	2"	4"
8"	278010	8USP-AL12	8"	8 7/8"	12"	2"	10"
8"	278016	8USP-AL18	8"	8 7/8"	18"	2"	16"
8"	278034	8USP-AL36	8"	8 7/8"	36"	2"	34"

WIDE FINISHING BANDS

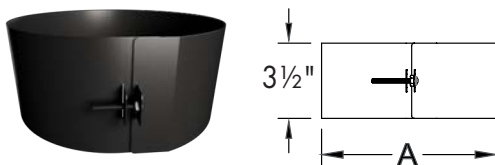

- 6", 7", and 8" diameters
- Use to conceal & finish connection between Ultimate StovePipe and chimney at the ceiling support or in a through the wall application
- Can also be used to conceal the connecting joint at the chimney adapter
- Hardware pack included

Note: Wide Finishing Band included with Telescopic Lengths

Size	Product Number	Part Number	A
6"	276261	6USP-WFB	6 7/8"
7"	277261	7USP-WFB	7 7/8"
8"	278261	8USP-WFB	8 7/8"

NARROW FINISHING BANDS

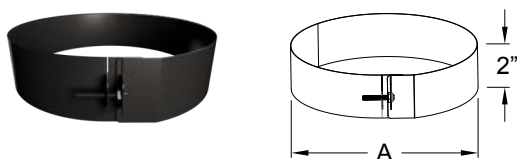

- 6", 7", and 8" diameters
- Use to conceal & finish connection between Ultimate StovePipe and chimney at the ceiling support or in a through the wall application
- For appliances with reduced clearance between wall and stove
- Hardware pack included

Note: Narrow Finishing Band is optional

Size	Product Number	Part Number	A
6"	276262	6USP-NFB	6 7/8"
7"	277262	7USP-NFB	7 7/8"
8"	278262	8USP-NFB	8 7/8"

- 6", 7", and 8" diameters
- Use fixed 30° elbow to offset flue as needed
- Non-positional connection system allows 360° rotation
- Hardware pack included

Size	Product Number	Part Number	A	B	C	D	E	F
6"	276211	6USP-E30	6"	6 7/8"	2 1/2"	3 1/2"	4 1/4"	1"
7"	277211	7USP-E30	7"	7 7/8"	2 5/8"	3 5/8"	4 1/2"	1 1/8"
8"	278211	8USP-E30	8"	8 7/8"	2 3/4"	3 3/4"	4 3/4"	1 1/8"

30° ELBOWS

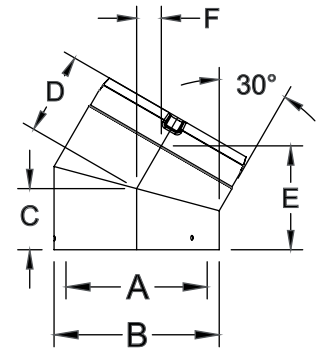

- 6", 7", and 8" diameters
- Use fixed 45° elbow to offset flue as needed
- Non-positional connection system allows 360° rotation
- Hardware pack included

Size	Product Number	Part Number	A	B	C	D	E	F
6"	276215	6USP-E45	6"	6 7/8"	3"	3 7/8"	4 7/8"	1 3/4"
7"	277215	7USP-E45	7"	7 7/8"	3 1/4"	4 1/8"	5 1/4"	2"
8"	278215	8USP-E45	8"	8 7/8"	3 1/2"	4 3/8"	5 5/8"	2 1/8"

45° ELBOWS

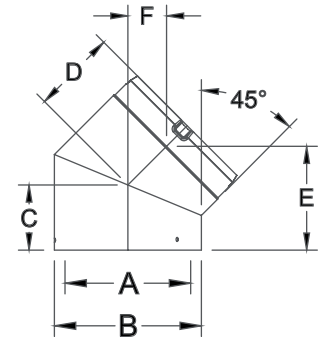

- 6", 7", and 8" diameters
- Use fixed 90° elbow to offset flue as needed, or in a through-the-wall installation
- Non-positional connection system allows 360° rotation
- Hardware pack included

Size	Product Number	Part Number	A	B	C	D	E	F	G
6"	276230	6USP-E90	6"	6 7/8"	3"	3 3/8"	4"	5 3/8"	4 7/8"
7"	277230	7USP-E90	7"	7 7/8"	3 1/4"	3 3/4"	4 1/8"	5 7/8"	5 3/8"
8"	278230	8USP-E90	8"	8 7/8"	3 1/2"	4 1/4"	4 3/8"	6 3/8"	5 7/8"

90° ELBOWS

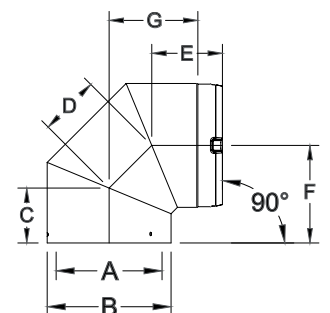

TEES

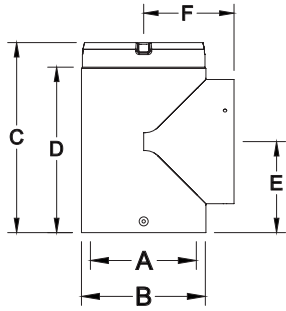

- 6", 7", and 8" diameters
- Includes Tee Cap for easy inspection & cleaning access
- Hardware pack included

Size	Product Number	Part Number	A	B	C	D	E	F
6"	276100	6USP-T	6"	6 7/8"	10 5/8"	9 1/4"	5 1/8"	5 1/8"
7"	277100	7USP-T	7"	7 7/8"	11 5/8"	10 1/4"	5 5/8"	5 5/8"
8"	278100	8USP-T	8"	8 7/8"	12 5/8"	11 1/4"	6 1/8"	6 1/8"

MASONRY ADAPTERS

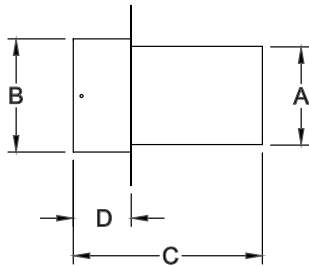
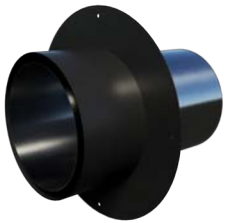

- 6", 7", and 8" diameters
- For installations through a masonry wall
- Use to connect Ultimate StovePipe to an existing masonry chimney or a relined masonry chimney with stainless steel liner
- Hardware pack included

Size	Product Number	Part Number	A	B	C	D
6"	276247	6USP-MA	6"	6 7/8"	11 1/2"	3 1/2"
7"	277247	7USP-MA	7"	7 7/8"		
8"	278247	8USP-MA	8"	8 7/8"		

INCREASERS

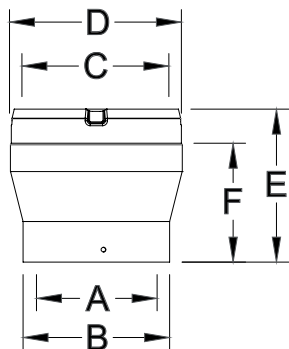

- 4 Sizes - 5" to 6", 6" to 7", 6" to 8" and 7" to 8"
- Use to increase to a larger diameter chimney system
- Hardware pack included

Note: Increasing the diameter may reduce draft and increase creosote build-up.

Size	Product Number	Part Number	A	B	C	D	E	F
5" to 6"	275306	5USP-IN6	5"	5 7/8"	6"	6 7/8"	6 1/8"	4 3/4"
6" to 7"	276307	6USP-IN7	6"	6 7/8"	7"	7 7/8"	6 1/8"	4 3/4"
6" to 8"	276308	6USP-IN8	6"	6 7/8"	8"	8 7/8"	8 1/8"	6 3/4"
7" to 8"	277308	7USP-IN8	7"	7 7/8"	8"	8 7/8"	6 1/8"	4 3/4"

- 3 sizes - 7" to 6", 8" to 7", and 8" to 6"
- Use to reduce the diameter of the system to accommodate a range of flue sizes
- Hardware pack included

Note: Check with appliance manufacturer or local code authorities for acceptable use.

Size	Product Number	Part Number	A	B	C	D	E	F
7" to 6"	277366	7USP-RE6	7"	7 7/8"	6"	6 7/8"	6 1/8"	4 3/4"
8" to 6"	278366	8USP-RE6	8"	8 7/8"	6"	6 7/8"	8 1/8"	6 3/4"
8" to 7"	278367	8USP-RE7	8"	8 7/8"	7"	7 7/8"	6 1/8"	4 3/4"

REDUCERS

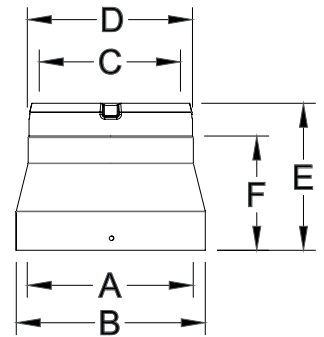

- 6", 7", and 8" diameters
- Use to connect Ultimate StovePipe to a flush, recessed or standard appliance outlet
- Pair with an Adjustable Length to conceal the Low Profile Adapter & create a seamless look

Size	Product Number	Part Number	A	B	C
6"	276249	6USP-LPSA	5 15/16"	6"	2 1/2"
7"	277249	7USP-LPSA	6 15/16"	7"	
8"	278249	8USP-LPSA	7 15/16"	8"	

LOW PROFILE STOVE ADAPTERS

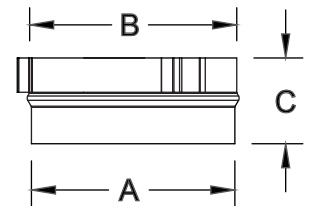

- 6" diameter
- Use to convert Jotul flue outlets to Ultimate StovePipe

Size	Product Number	Part Number	A	B	C	D
6"	276245	6USP-SAJOTUL	6"	6 7/8"	6 5/8"	4 1/4"

JOTUL STOVE ADAPTER

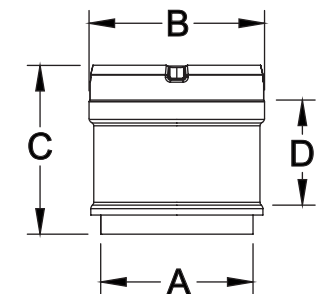

OVAL-TO-ROUND ADAPTERS



- 8" oval diameters
- Use to convert Oval flue outlets to round Ultimate StovePipe
- Hardware pack included

Size	Product Number	Part Number	A	B	C	D	E	F
8" to 8"	278250	8USP-ORA	6" x 10 5/8"	6 3/4" x 11 1/2"	8"	8 7/8"	15 1/4"	12 7/8"
8" to 6"	278251	8USP-ORA6	6" x 10 5/8"	6 3/4" x 11 1/2"	6"	6 7/8"		

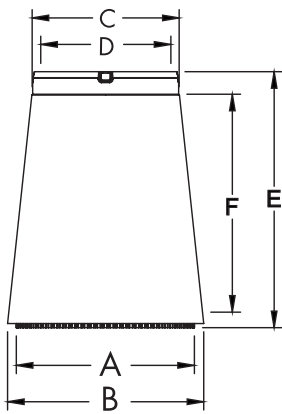

IN-LINE DAMPERS



- 6", 7", and 8" diameters
- Use to control the air being drawn through the chimney and to control the stove's combustion
- Designed to be installed in a vertical run 2 to 3 feet above the stove
- Hardware pack included

Note: Check with appliance manufacturer for recommended use.

Size	Product Number	Part Number	A	B	C	D
6"	276260	6USP-DK	6"	6 7/8"	6"	4 5/8"
7"	277260	7USP-DK	7"	7 7/8"		
8"	278260	8USP-DK	8"	8 7/8"		

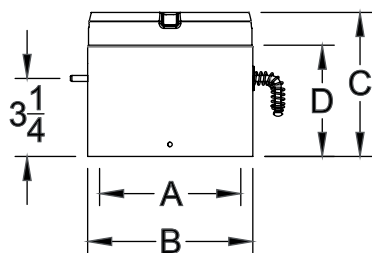

ELBOW OFFSET CHART

30° Elbow - 2x E30 with 1x Length				45° Elbow - 2x E45 with 1x Length				90° Elbow - 2x E90 with 1x Length			
Size	Pipe Length	X - Offset	Y - Rise	Size	Pipe Length	X - Offset	Y - Rise	Size	Pipe Length	X - Offset	Y - Rise
6"	0"	2 1/4"	8 5/8"	6"	0"	4"	9 1/2"	6"	0"	10 3/8"	10 3/8"
	6"	4 5/8"	12 5/8"		6"	7 1/4"	12 3/4"		6"	15"	
	12"	7 1/2"	17 7/8"		12"	11 1/2"	17"		12"	21"	
	18"	10 1/2"	23"		18"	15 3/4"	21 1/4"		18"	27"	
	24"	13 1/2"	28 1/4"		24"	20"	25 1/2"		24"	33"	
	36"	19 1/2"	38 5/8"		36"	28 1/2"	34"		36"	45"	
	48"	25"	48 1/8"		48"	36 1/4"	41 3/4"		48"	56"	
7"	0"	2 3/8"	9 1/8"	7"	0"	4 1/4"	10 1/4"	7"	0"	11 3/8"	11 3/8"
	6"	4 3/4"	13 1/8"		6"	7 1/2"	13 1/2"		6"	16"	
	12"	7 5/8"	18 3/8"		12"	11 3/4"	17 3/4"		12"	22"	
	18"	10 5/8"	23 1/2"		18"	16"	22"		18"	28"	
	24"	13 5/8"	28 3/4"		24"	20 1/4"	26 1/4"		24"	34"	
	36"	19 5/8"	39 1/8"		36"	28 3/4"	34 3/4"		36"	46"	
	48"	25 1/8"	48 5/8"		48"	36 1/2"	42 1/2"		48"	57"	
8"	0"	2 5/8"	9 5/8"	8"	0"	4 1/2"	11"	8"	0"	12 3/8"	12 3/8"
	6"	5"	13 5/8"		6"	7 3/4"	14 1/4"		6"	17"	
	12"	7 7/8"	18 7/8"		12"	12"	18 1/2"		12"	23"	
	18"	10 7/8"	24"		18"	16 1/4"	22 3/4"		18"	29"	
	24"	13 7/8"	29 1/4"		24"	20 1/2"	27"		24"	35"	
	36"	19 7/8"	39 5/8"		36"	29"	35 1/2"		36"	47"	
	48"	25 3/8"	49 1/8"		48"	36 3/4"	43 1/4"		48"	58"	

30° Elbow - 2x E30 with 1x Telescopic Length						
Size	Telescopic Length		X - Offset		Y - Rise	
	MIN	MAX	MIN	MAX	MIN	MAX
6"	35 3/4"	68 1/8"	20 1/8"	36 1/4"	39 5/8"	67 5/8"
7"	35 3/4"	68 1/8"	20 1/4"	36 3/8"	40 1/8"	68 1/8"
8"	35 3/4"	68 1/8"	20 1/2"	36 5/8"	40 5/8"	68 5/8"

45° Elbow - 2x E45 with 1x Telescopic Length						
Size	Telescopic Length		X - Offset		Y - Rise	
	MIN	MAX	MIN	MAX	MIN	MAX
6"	35 3/4"	68 1/8"	29 1/4"	52 1/8"	34 3/4"	57 5/8"
7"	35 3/4"	68 1/8"	29 1/2"	52 3/8"	35 1/2"	58 3/8"
8"	35 3/4"	68 1/8"	29 3/4"	52 5/8"	36 1/4"	59 1/8"

90° Elbow - 2x E90 with 1x Telescopic Length						
Size	Telescopic Length		X - Offset		Y - Rise	
	MIN	MAX	MIN	MAX	MIN	MAX
6"	35 3/4"	68 1/8"	46 1/8"	78 1/2"	10 3/8"	
7"	35 3/4"	68 1/8"	47 1/8"	79 1/2"	11 3/8"	
8"	35 3/4"	68 1/8"	48 1/8"	80 1/2"	12 3/8"	

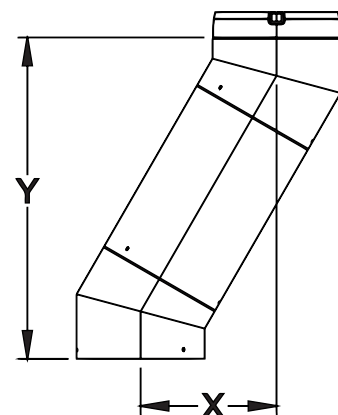



BUILD FOR THE FUTURE

Customer Service and Support:

Airmate (USA).....	800.992.8368
Airmate (CAN)	888.735.5475
Ameriflow	800.252.8467
Amerivent (Retail).....	800.252.8467
Amerivent (Hearth & Wholesale)	800.423.4270
Amerivent (Support).....	800.748.0392
AMPCO (USA)	800.669.3269
AMPCO (CAN).....	888.735.5475
Duravent	800.835.4429
Hart & Cooley.....	800.433.6341
Hart & Cooley (Support)	800.748.0392
Heatfab (USA).....	800.772.0739
Heatfab (CAN)	800.848.2149
Lima.....	800.423.4270
Milcor	800.774.5240
Portals Plus.....	800.774.5240
RPS.....	800.624.8642
Security Chimney (USA).....	800.361.4909
Security Chimney (CAN)	800.667.3387
Selkirk (USA) Residential	800.992.8368
Selkirk (USA) Commercial.....	800.848.2149
Selkirk (USA) Support.....	800.748.0392
Selkirk (CAN).....	888.735.5475

Manufacturing & Distribution Centers:

CANADA	
Nobel, ON	Manufacturing
Laval, QC	Manufacturing
Prescott, ON	Distribution
USA	
Grand Rapids, MI	Center of Excellence
Dallas, TX	Distribution
Englewood, OH	Distribution
Huntsville, AL	Manufacturing & Distribution
Mira Loma, CA	Distribution
Nampa, ID	Manufacturing & Distribution
Turner Falls, MA	Manufacturing & Distribution
Vacaville, CA	Manufacturing
MEXICO	
Ojinaga, MX	Manufacturing
Mexicali, MX	Manufacturing

Corporate Headquarters:

Duravent Group
 28 W. Adams, Suite 1810
 Detroit, MI 48226
 Tel: 800.835.4429
 Email: info@duraventgroup.com
www.duraventgroup.com



duravent[™]



duravent[™]
GROUP

BUILD FOR THE FUTURE

www.duraventgroup.com



For warranty information:
Scan this QR code or visit
www.duraventgroup.com/warranties