

# PRODUCT CATALOGUE

## RIGID STAINLESS STEEL CHIMNEY LINER

5" TO 8" DIAMETER



WOOD



GAS



OIL



Intertek

Listed To: ULC-S635, ULC-S640 and UL 1777

Get the Selkirk Advantage...

*The tradition continues....Selkirk is the original innovator of prefabricated Venting systems - and we continue to move forward. Count on Selkirk, the world's most recognizable name in Chimney & Venting, for the widest range of high-performance products to meet your needs.*





## Rigid Stainless Steel Liner for Wood, Oil or Gas Appliances

### Kits

#### Starter Kit



- The Starter Kit contains most parts required for your installation
- Includes Round Top, Flashing, Flashing Adaptor, Tee w/Cap, 18" Adjustable Length, Support Straps, Tee/Stove Adaptor

SIZE	PRODUCT CODE	PART #	PACK
5"	195165	5RFSK	1
6"	196165	6RFSK	1
7"	197165	7RFSK	1
8"	198165	8RFSK	1

#### Insulation Wrap Kit



- 10 ft. Kit includes foil-backed insulation, wire mesh, stainless steel ties and aluminum tape
- Reduces heat loss to maintain high flue temperatures
- A requirement for UL 1777 - allows for reduced clearance to combustibles (see installation instructions for details)

SIZE	PRODUCT CODE	PART #	PACK
5"	195120	5RF10I	1
6"	196120	6RF10I	1
7"	197120	7RF10I	1
8"	198120	8RF10I	1

# Rigid Stainless Steel Liner for Wood, Oil or Gas Appliances

## Parts & Accessories

### Pipe Length

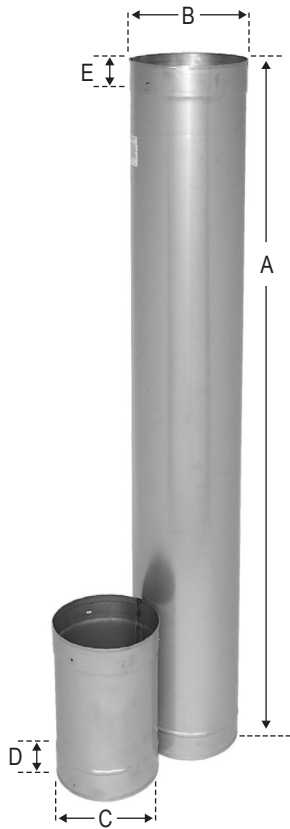

- Lengths are 304 Stainless Steel
- Available in Lengths of 6", 12", 24", 36" and 48"
- Available in diameters of 5", 6", 7" and 8"
- Three rivets per Length

SIZE	DIMENSIONS					PRODUCT CODE	PART #	PACK
	A	B	C	D	E			
5"	47.5"	5"	4-7/8"	2"	2-1/8"	195048	5RF48	4
6"	47.5"	6"	5-7/8"	2"	2-1/8"	196048	6RF48	4
7"	47.5"	7"	6-7/8"	2"	2-1/8"	197048	7RF48	4
8"	47.5"	8"	7-7/8"	2"	2-1/8"	198048	8RF48	4
5"	35.5"	5"	4-7/8"	2"	2-1/8"	195036	5RF36	4
6"	35.5"	6"	5-7/8"	2"	2-1/8"	196036	6RF36	4
7"	35.5"	7"	6-7/8"	2"	2-1/8"	197036	7RF36	4
8"	35.5"	8"	7-7/8"	2"	2-1/8"	198036	8RF36	4
5"	23.5"	5"	4-7/8"	2"	2-1/8"	195024	5RF24	1
6"	23.5"	6"	5-7/8"	2"	2-1/8"	196024	6RF24	1
7"	23.5"	7"	6-7/8"	2"	2-1/8"	197024	7RF24	1
8"	23.5"	8"	7-7/8"	2"	2-1/8"	198024	8RF24	1
5"	12"	5"	4-7/8"	2"	2-1/8"	195012	5RF12	1
6"	12"	6"	5-7/8"	2"	2-1/8"	196012	6RF12	1
7"	12"	7"	6-7/8"	2"	2-1/8"	197012	7RF12	1
8"	12"	8"	7-7/8"	2"	2-1/8"	198012	8RF12	1
5"	6"	5"	4-7/8"	2"	2-1/8"	195006	5RF6	1
6"	6"	6"	5-7/8"	2"	2-1/8"	196006	6RF6	1
7"	6"	7"	6-7/8"	2"	2-1/8"	197006	7RF6	1
8"	6"	8"	7-7/8"	2"	2-1/8"	198006	8RF6	1

### Adjustable Length

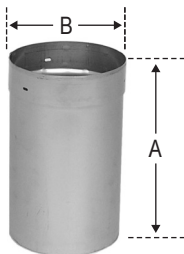

- Used to adjust the liner to the required length
- Adjustable from 4-1/2" to 14"

SIZE	DIMENSIONS		PRODUCT CODE	PART #	PACK
	A	B			
5"	18"	5"	195084	5RFAL	1
6"	18"	6"	196084	6RFAL	1
7"	18"	7"	197084	7RFAL	1
8"	18"	8"	198084	8RFAL	1

# Rigid Stainless Steel Liner for Wood, Oil or Gas Appliances

## Parts & Accessories

### 45 Degree Elbow

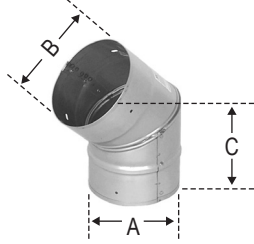

- Use in an offset installation

SIZE	DIMENSIONS			PRODUCT CODE	PART #	PACK
	A	B	C			
5"	4-7/8"	5"	7-15/16"	195215	5RF45	1
6"	5-7/8"	6"	8-3/8"	196215	6RF45	1
7"	6-7/8"	7"	8-5/8"	197215	7RF45	1
8"	7-7/8"	8"	9-1/16"	198215	8RF45	1

### 90 Degree Elbow

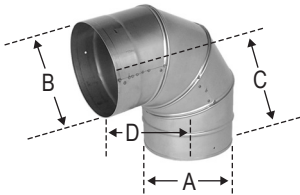

- Use in an offset installation

SIZE	DIMENSIONS				PRODUCT CODE	PART #	PACK
	A	B	C	D			
5"	4-7/8"	5"	6-3/4"	6-3/8"	195230	5RF90	1
6"	5-7/8"	6"	7-3/8"	6-3/4"	196230	6RF90	1
7"	6-7/8"	7"	7-3/4"	7-3/8"	197230	7RF90	1
8"	7-7/8"	8"	8-3/8"	7-3/4"	198230	8RF90	1

### Tee Section with Cap

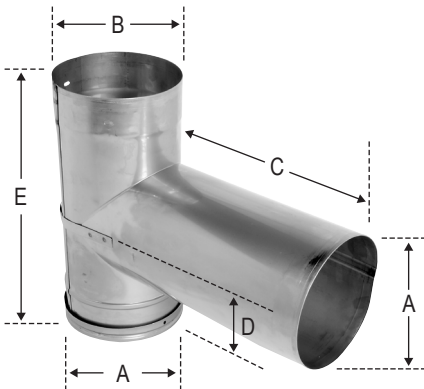

- 2 piece design for easy installation into a masonry chimney
- Comes complete with Tee Cap
- Tee branch may be cut to size where required

SIZE	DIMENSIONS					PRODUCT CODE	PART #	PACK
	A	B	C	D	E			
5"	4-7/8"	5"	10"	6-1/2"	13"	195100	5RFTE	1
6"	5-7/8"	6"	10"	6-1/2"	13"	196100	6RFTE	1
7"	6-7/8"	7"	10"	6-1/2"	13"	197100	7RFTE	1
8"	7-7/8"	8"	10"	6-1/2"	13"	198100	8RFTE	1

# Rigid Stainless Steel Liner for Wood, Oil or Gas Appliances

## Parts & Accessories

### Flashing & Flashing Adapter

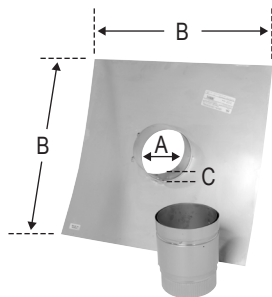

- Used at the top of the masonry chimney as support

SIZE	DIMENSIONS			PRODUCT CODE	PART #	PACK
	A	B	C			
5"	5-3/8"	20"	3"	195850	5RFFA	1
6"	6-3/8"	20"	3"	196850	6RFFA	1
7"	7-3/8"	20"	3"	197850	7RFFA	1
8"	8-3/8"	20"	3"	198850	8RFFA	1

### Round Top

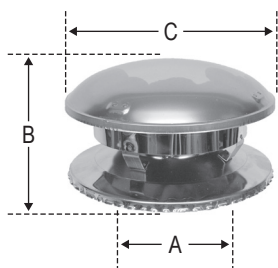

- Advanced design, premium quality stainless steel
- Provides protection against precipitation and creates a venturi effect to enhance draught
- Secured in position with stainless steel screws providing easy removal for inspection and cleaning

SIZE	DIMENSIONS			PRODUCT CODE	PART #	PACK
	A	B	C			
5"	4-7/8"	7-3/4"	10"	195800	5RFRT	1
6"	5-7/8"	8-1/2"	12"	196800	6RFRT	1
7"	6-7/8"	9-1/8"	14"	197800	7RFRT	1
8"	7-7/8"	10"	16"	198800	8RFRT	1

### DIKAPT (Anti Downdraft Cap)

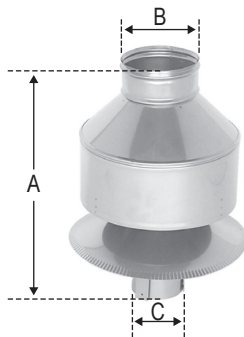

- Provides protection from wind and rain during cold chimney conditions
- Ensures normal flow of hot gases during windy conditions
- Constructed of 300 Series Stainless Steel

SIZE	DIMENSIONS			PRODUCT CODE	PART #	PACK
	A	B	C			
5"	17-1/4"	6"	4-3/4"	195802	5RFDK	1
6"	19-1/4"	7"	5-3/4"	196802	6RFDK	1
7"	19-1/4"	8"	6-3/4"	197802	7RFDK	1
8"	19-1/4"	9"	7-3/4"	198802	8RFDK	1

### Flex Connector

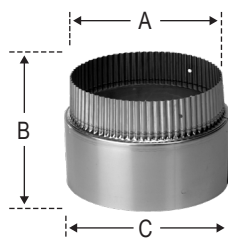

- Fitting used for joining Flex and Rigid components
- Crimped for ease of assembly

SIZE	DIMENSIONS			PRODUCT CODE	PART #	PACK
	A	B	C			
4"	4"	3.97"	5.35"	174060	SF4-FC	1
5"	5"	4.97"	6.35"	175060	5RFFC	1
6"	6"	5.97"	7.35"	176060	6RFFC	1
7"	7"	6.97"	8.35"	177060	7RFFC	1
8"	8"	7.97"	9.35"	178060	8RFFC	1

# Rigid Stainless Steel Liner for Wood, Oil or Gas Appliances

## Parts & Accessories

### 5" Flex to 6" Stove Adapter

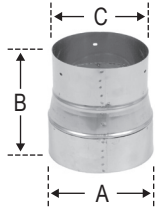

- Provides transition from a 6" appliance outlet to a 5" diameter Flex Liner
- Crimped for ease of assembly

SIZE	DIMENSIONS			PRODUCT CODE	PART #	PACK
	A	B	C			
5" to 6"	6"	6-1/4"	5"	175230	5RF6SA	1

### Increaser

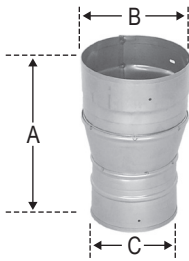

- To increase liner to a larger diameter

SIZE	DIMENSIONS			PRODUCT CODE	PART #	PACK
	A	B	C			
5" to 6"	9-3/8"	6"	4-7/8"	195306	5RF6I	1
6" to 7"	9-3/8"	7"	5-7/8"	196307	6RF7I	1
7" to 8"	9-3/8"	8"	6-7/8"	197308	7RF8I	1

### Reducer



- To reduce liner to a smaller diameter

SIZE	DIMENSIONS			PRODUCT CODE	PART #	PACK
	A	B	C			
6" to 5"	9-3/8"	5"	5-7/8"	196365	6RF5R	1
7" to 6"	9-3/8"	6"	6-7/8"	197366	7RF6R	1
8" to 7"	9-3/8"	7"	7-7/8"	198367	8RF7R	1

### Trim Plate

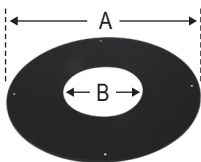

- Matte black finish provides a decorative finish to installation.
- Has four holes with black screws for mounting.

SIZE	DIMENSIONS			PRODUCT CODE	PART #	PACK
	A	B				
5"	12"	5-1/8"		195500	5RFTP	1
6"	12"	6-1/8"		196500	6RFTP	1
7"	14"	7-1/8"		197500	7RFTP	1
8"	14"	8-1/8"		198500	8RFTP	1

### Support Bracket

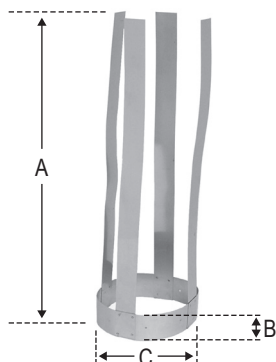

- Additional support for liner, also used above each offset
- Used only with rigid components

SIZE	DIMENSIONS			PRODUCT CODE	PART #	PACK
	A	B	C			
5"	22"	2"	5"	195200	SL5SB	1
6"	22"	2"	6"	196200	SL6SB	1
7"	22"	2"	7"	197200	SL7SB	1
8"	22"	2"	8"	198200	SL8SB	1



# The Best Warranty in the Industry

Rigid Stainless Steel Liner features advanced engineering designs and premium materials which allow us to offer a Lifetime Warranty.

See written warranty for details.

## All Hearth Products Are Not Created Equal



Flexible Aluminum Chimney Liners



Stainless Steel Chimney Liners



UltimatePellet Pipe



**UltimateOne**<sup>™</sup>  
AL-FUEL CHIMNEY FOR HEARTH PROFESSIONALS



Double Wall DCC Stove Pipe



Direct Vent Pipe for Gas, Pellet, or Multi Fuel



[www.selkirkcorp.ca](http://www.selkirkcorp.ca)

**Selkirk Canada**  
950 South Service Road  
Second Floor  
Stoney Creek, ON L8E 6A2  
Toll Free: 1.888.SELKIRK (735.5475)