



Model RV

Type B Gas Vent

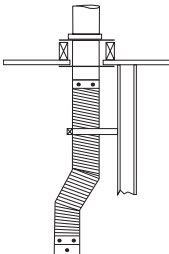

TABLE OF CONTENTS

Typical Installations	3
Technical Data Sheet	4
Vent Pipe.....	5-7
Elbows, Tees and Wyes	7-9
Tops, Supports and Firestops	10-12
Flashings and Storm Collars	13-14
Termination Kit.....	14
Adapters, Connectors and Increasers	15-18
Oval Vent Pipe.....	18-19
Oval Elbows and Tees	19
Oval Tops, Supports and Firestops	19-20
Flashings and Storm Collar.....	21
Oval Adapters, Connectors and Increasers.....	22
DWC Double Wall Flexible Gas Vent Pipe	23
Gas Appliance Chimney Liner Systems	24-26
Submittal Specifications (USA ONLY).....	26

Typical Installations

DWC DOUBLE WALL FLEXIBLE GAS VENT PIPE



OFFSET THRU CEILING

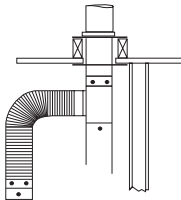

90° OFFSET W/TEE

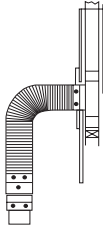

THRU THE WALL

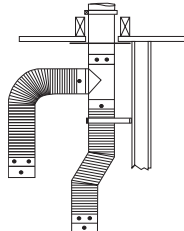

COMBINED VENT THRU CEILING

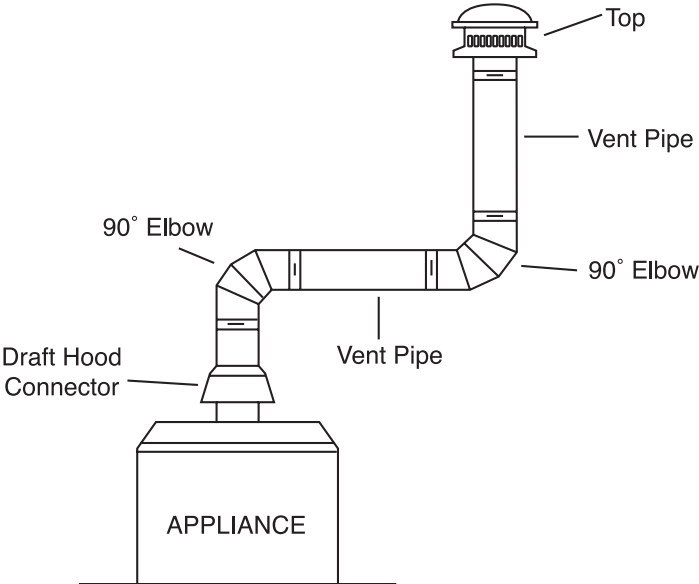
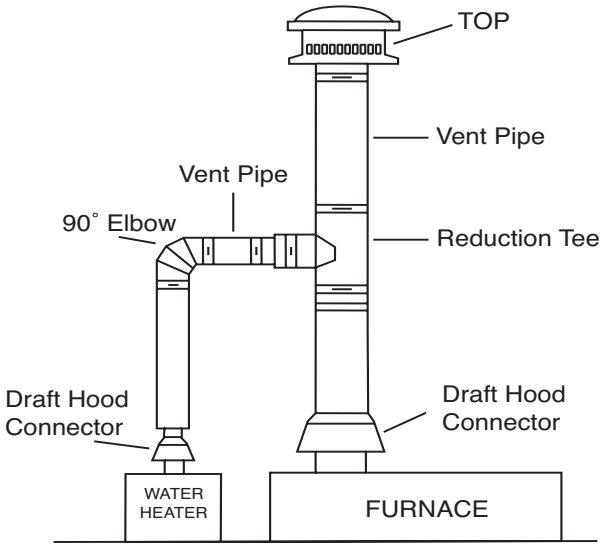
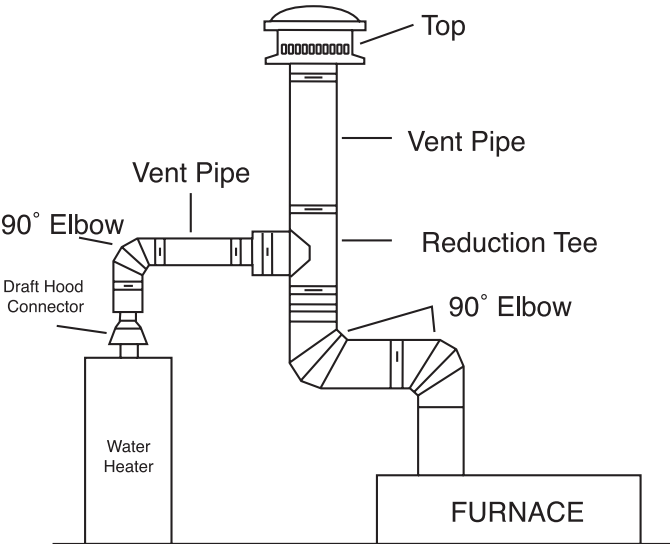

Type "B" Gas Vent

TABLE OF CONTENTS



RV

Round Vent Pipe 3" through 8".....5-18

Selkirk RV round vent pipe is a Listed Type B gas vent pipe. Lengths available range from 6" to 5'. Its adjustable fittings and standard short lengths eliminate all cutting, fitting and special engineering. An improved joint design provides for a rapid and secure connection in seconds. The use of our "LockTab" feature gives installers the option of engaging this tab instead of using sheet metal screws.



OVAL

Oval Vent Pipe 4", 5" and 6".....18-22

Selkirk oval vent pipe, sizes 4", 5" and 6" provides the venting capacity of 4", 5" and 6" round vent pipe. 4" is Listed for both Type B, and Type BW, use/installation in a 2 x 4 wall. 5" is Listed for Type B use/installation in a 2 x 4 and 2 x 6 wall. 6" is Listed for Type B use/installation in a 2 x 6 wall.



DWC/EFC

Double Wall/Expandable Flexible Connectors.....23

Selkirk EFC Expandable Flexible Gas Vent Connector is available in 3" and 4" diameters in 1'-3' and 2'-5' lengths. Selkirk DWC Double Wall Flexible Gas Vent Connector is available in 3", 4", & 5" diameters in 2', 3', 4', & 5' lengths designed for easy connection to standard Type B Gas Vent. DWC is now Listed for use as a "segment" of an unenclosed Type B gas vent system and has full safety certification for use in conditioned and/or unconditioned attics and crawl spaces (USA only). DWC can simplify alignment of most installations by enabling a quick and easy offset between sections of rigid gas vent.



FLEXI-LINER

Aluminum Flexible Chimney Liner For Gas Appliances.....24-26

Available in 25' and 35' lengths, 3" to 8" diameters - 15' kits also available in 3", 4" and 5" diameters. Flexi-Liner kits include Flexi-Liner, Round Top (RV), Flashing with 3" collar and Mortar Guard.

Rugged Construction

Strong, durable galvanized steel outer pipe has internal spacing beads to assure a uniform insulating air space between pipe walls. Each end is die formed to assure uniform sizing for strong, easy to connect joints which resist wasteful handling and shipping damage. In Canada, some lengths are available in galvalume steel outer pipe.

The inner aluminum pipe is attached to the outer pipe at only one end. This arrangement allows for differential expansion between the two pipes, eliminating operational noises.

Assured Safety

The double wall (pipe within a pipe) construction with its built-in air space, provides permanent insulation and keeps the inner pipe hot and the outer pipe relatively cool. Such construction creates quick, strong vent action and eliminates condensation in the pipe or overheating of nearby enclosure surfaces.

With special factory supplied parts, 4" OV oval pipe can be installed at less than one inch clearance to combustible surfaces as a Type BW vent for recessed wall furnaces or as a Type B vent through 2 x 4 walls. Check with local authorities if Type BW vent is permissible in your area.

Fully Tested And Listed

Selkirk Gas Vent pipe and fittings have been tested and listed per UL 441 for installation as Type B and BW gas vents to be installed in single and multi-story buildings in accordance with the standards of The National Fire Protection Association NFPA54 and NFPA211. In Canada, Selkirk Gas Vent pipe and fittings have been tested and listed per CAN/ULC-S605 for installation as Type B and BW gas vents and to be installed in single and multi-story buildings in accordance with the Installation Code CSA B-149.

They must be enclosed in occupied portions of a building. When the enclosure is made of combustible material, sizes 3"- 8" diameter pipe must have 1" clearance. Refer to Selkirk illustrated installation instructions for proper procedures.

Warning

The products in this catalog are only for use on listed natural gas or liquid propane Category 1 appliances. Do not use any gas vent on oil or woodburning appliances. These fuels can produce temperatures which may damage the gas vent with resulting hazard to both life and property. These gas vents are not suitable for use when sealed, pressure type, or leakproof systems are called for. For residential "high efficiency" gas burning appliances, which may need sealed systems, Type B vents may be used only if allowed by the appliance manufacturer's installation instructions.

SPECIFICATIONS FOR VENTING APPROVED GAS BURNING APPLIANCES WITH TYPE B GAS VENT PIPE

The gas vent system shall be so engineered and constructed as to develop a positive flow adequate to exhaust all flue gases to outside atmosphere, without condensation within the vent or spillage at any appliance draft hood.

Selkirk gas vent piping shall be installed in full compliance with the terms of its Underwriters' Laboratories, Inc. Listing, with the manufacturer's installation instructions, and with nationally recognized codes representing good practice for such installations.

All flue-gas carrying parts of the vent system shall be Selkirk Type B double-wall gas vent piping, and such piping shall be continuous from the appliances' outlets into the Selkirk vent top of housing.

LOCKTAB® Type "B" Gas Vent

Model RV Type B Gas Vent



To use the LockTab® feature:

Our non-positional lock system on the Selkirk® RV Gas Vent is the best lock system on the market today. The incorporation of the LockTab® feature simply improves our lock system by adding flexibility and meeting market needs.

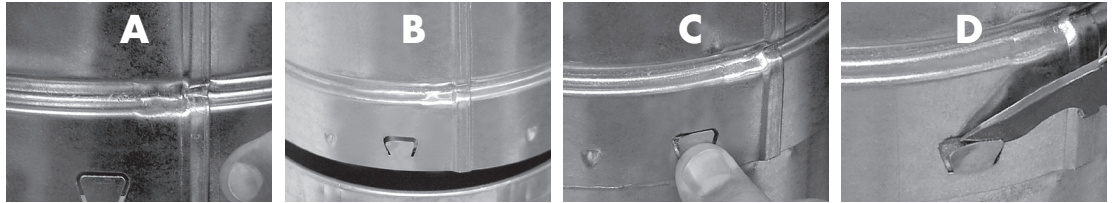

RV 3" through 8"

The RV line of Selkirk round vent pipe and fittings is designed for use on approved gas appliances in residential and light commercial and industrial applications. Round vents for large appliances will be found in the separate catalog for Model R.

NOTE: Size refers to the inside diameter of the pipe or fitting. The outside diameter of RV is approximately 1/2" larger. Outer material is 28 GA galvanized steel. Inner liner is aluminum. In Canada some lengths and fittings are available in galvalume steel.

LOCKTAB: You no longer have to use sheet metal screws to secure pipe connections if required by local code. Just press the "LockTab" and you are done.

Vent Pipe

- Available in 6 diameters.
- Easy to assemble and can be combined to obtain the required installation height
- Sectional overlap of 1.5". Hence, net assembled length is 1.5" less than listed lengths

ROUND PIPE

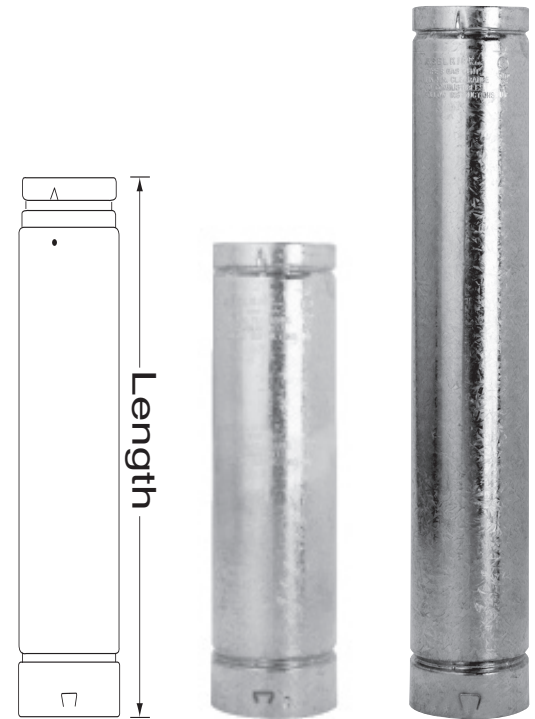

NOTE: For installation in Canada order "Azm 150" only.

Size	Product No.	Part No.	Lengths
3"	103006	3RV-6	Pipe-6"
3"	103007	3RV-6C	Pipe-6" Azm 150
3"	103012	3RV-12	Pipe-12"
3"	103013	3RV-12C	Pipe-12" Azm 150
3"	103018	3RV-18	Pipe-18"
3"	103019	3RV-18C	Pipe-18" Azm 150
3"	103024	3RV-24	Pipe-2'
3"	103036	3RV-36	Pipe-3'
3"	103037	3RV-36C	Pipe-3' Azm 150
3"	103048	3RV-48	Pipe-4'
3"	103060	3RV-60	Pipe-5'
3"	103061	3RV-60C	Pipe-5' Azm 150
4"			
4"	104006	4RV-6	Pipe-6"
4"	104007	4RV-6C	Pipe-6" Azm 150
4"	104012	4RV-12	Pipe-12"
4"	104013	4RV-12C	Pipe-12" Azm 150
4"	104018	4RV-18	Pipe-18"
4"	104019	4RV-18C	Pipe-18" Azm 150
4"	104024	4RV-24	Pipe-2'
4"	104025	4RV-24C	Pipe-24" Azm 150
4"	104036	4RV-36	Pipe-3'
4"	104037	4RV-36C	Pipe-3' Azm 150

ROUND PIPE continued

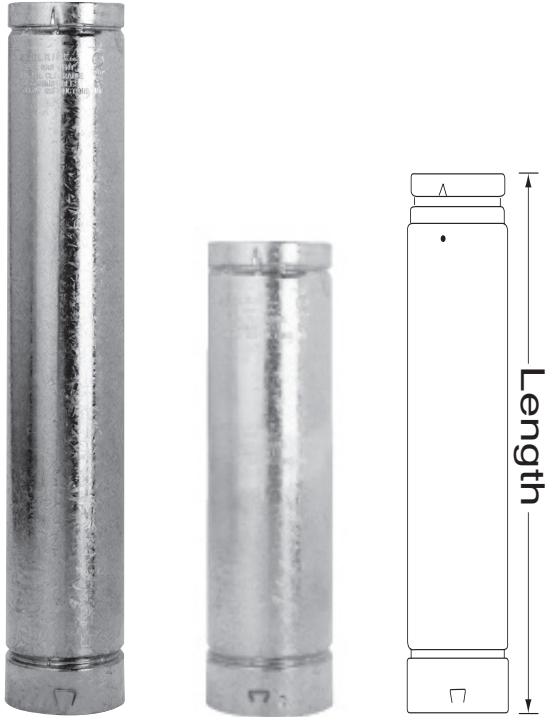

NOTE: For installation in Canada order "Azm 150" only.

Size	Product No.	Part No.	Lengths
4"	104048	4RV-48	Pipe-4'
4"	104060	4RV-60	Pipe-5'
4"	104061	4RV-60C	Pipe-5' Azm150
5"	105006	5RV-6	Pipe-6"
5"	105007	5RV-6C	Pipe-6" Azm150
5"	105012	5RV-12	Pipe-12"
5"	105013	5RV-12C	Pipe-12" Azm150
5"	105018	5RV-18	Pipe-18"
5"	105019	5RV-18C	Pipe-18" Azm150
5"	105024	5RV-24	Pipe-2'
5"	105025	5RV-24C	Pipe-24" Azm150
5"	105036	5RV-36	Pipe-3'
5"	105037	5RV-36C	Pipe-3' Azm150
5"	105048	5RV-48	Pipe-4'
5"	105060	5RV-60	Pipe-5'
5"	105061	5RV-60C	Pipe-5' Azm150
6"	106006	6RV-6	Pipe-6"
6"	106007	6RV-6C	Pipe-6" Azm150
6"	106012	6RV-12	Pipe-12"
6"	106013	6RV-12C	Pipe-12" Azm150
6"	106018	6RV-18	Pipe-18"
6"	106019	6RV-18C	Pipe-18" Azm150
6"	106024	6RV-24	Pipe-2'
6"	106025	6RV-24C	Pipe-24" Azm150
6"	106036	6RV-36	Pipe-3'
6"	106037	6RV-36C	Pipe-3' Azm150
6"	106048	6RV-48	Pipe-4'
6"	106060	6RV-60	Pipe-5'
6"	106061	6RV-60C	Pipe-5' Azm150
7"	107006	7RV-6	Pipe-6"
7"	107012	7RV-12	Pipe-12"
7"	107013	7RV-12C	Pipe-12" Azm150
7"	107018	7RV-18	Pipe-18"
7"	107019	7RV-18C	Pipe-18" Azm150
7"	107024	7RV-24	Pipe-2'
7"	107025	7RV-24C	Pipe-24" Azm150
7"	107036	7RV-36	Pipe-3'
7"	107037	7RV-36C	Pipe-3' Azm150
7"	107048	7RV-48	Pipe-4'
7"	107060	7RV-60	Pipe-5'
7"	107061	7RV-60C	Pipe-5' Azm150
8"	108006	8RV-6	Pipe-6"
8"	108012	8RV-12	Pipe-12"
8"	108018	8RV-18	Pipe-18"
8"	108019	8RV-18C	Pipe-18" Azm150
8"	108024	8RV-24	Pipe-2'
8"	108036	8RV-36	Pipe-3'
8"	108037	8RV-36C	Pipe-3' Azm150
8"	108048	8RV-48	Pipe-4'
8"	108060	8RV-60	Pipe-5'
8"	108061	8RV-60C	Pipe-5' Azm150

Vent Pipe continued

- Used in combination with a straight length, this component assures that an exact required vent length can be achieved
- Allows for easy disassembly and can absorb the linear expansion of longer pipe lengths.
- 12" Length adjusts from 3 1/2" to 10 1/2"
- 18" Length adjusts from 6" to 16"

Size	Product No.	Part No.	Lengths
3"	103082	3RV-AJ12	12"
3"	103083	3RV-AJ12C	12" - Azm 150
3"	103084	3RV-AJ18	18"
3"	103089	3RV-AJ18C	18" - Azm 150
4"	104082	4RV-AJ12	12"
4"	104084	4RV-AJ18	18"
4"	104089	4RV-AJ18C	18" - Azm 150
5"	105082	5RV-AJ12	12"
5"	105084	5RV-AJ18	18"
5"	105089	5RV-AJ18C	18" - Azm 150
6"	106082	6RV-AJ12	12"
6"	106083	6RV-AJ12C	12" - Azm 150
6"	106084	6RV-AJ18	18"
6"	106089	6RV-AJ18C	18" - Azm 150
7"	107082	7RV-AJ12	12"
7"	107083	7RV-AJ12C	12" - Azm 150
8"	108082	8RV-AJ12	12"
8"	108083	8RV-AJ12C	12" - Azm 150

ADJUSTABLE LENGTH



NOTE: For installation in Canada order "Azm 150" only.

Elbows, Tees and Wyes

- Used when an offset is required to avoid obstructions such as rafters, joists and other construction obstacles
- Used to orient pipe between vertical and horizontal orientation
- Four piece adjustable elbow twists for easy offsets

Size	Product No.	Part No.	A	B
3"	103230	3RV-90	6-3/8"	4-1 1/16"
3"	103235	3RV-90 - Azm 150	6-3/8"	4-1 1/16"
4"	104230	4RV-90	6-3/8"	4-1 1/16"
4"	104235	4RV-90 - Azm 150	6-3/8"	4-1 1/16"
5"	105230	5RV-90	6-3/8"	4-1 1/16"
5"	105235	5RV-90 - Azm 150	6-3/8"	4-1 1/16"
6"	106230	6RV-90	6-3/8"	4-1 1/16"
6"	106235	6RV-90 - Azm 150	6-3/8"	4-1 1/16"
7"	107230	7RV-90	8"	6-1/2"
7"	107235	7RV-90 - Azm 150	8"	6-1/2"
8"	108230	8RV-90	8-1/4"	6-3/4"
8"	108235	8RV-90 - Azm 150	8-1/4"	6-3/4"

90° ADJUSTABLE ELBOW

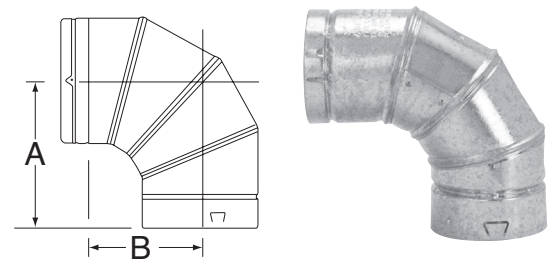

NOTE: For installation in Canada order "Azm 150" only.

Elbows, Tees and Wyes continued

45° / 60° ADJUSTABLE ELBOW

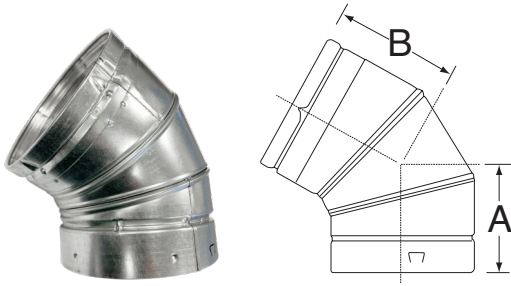

NOTE: For installation in Canada order "Azm 150" only.

- Used when an offset is required to avoid obstructions such as rafters, joists and other construction obstacles.
- Three piece adjustable elbow twists for easy offsets.

Size	Product No.	Part No.	Outer	A	B
3"	103222	3RV-EL45/60	3-1/2"	4-3/8"	4-1 1/16"
3"	103223	3RV-45 - Azm 150		4-3/8"	4-1 1/16"
4"	104222	4RV-EL45/60	4-1/2"	4-3/8"	4-1 1/16"
4"	104223	4RV-45 - Azm 150		4-3/8"	4-1 1/16"
5"	105222	5RV-EL45/60	5-1/2"	4-3/8"	4-1 1/16"
5"	105223	5RV-45 - Azm 150		4-3/8"	4-1 1/16"
6"	106222	6RV-EL45/60	6-1/2"	4-3/8"	4-1 1/16"
6"	106223	6RV-45 - Azm 150		4-3/8"	4-1 1/16"

45° ADJUSTABLE ELBOW

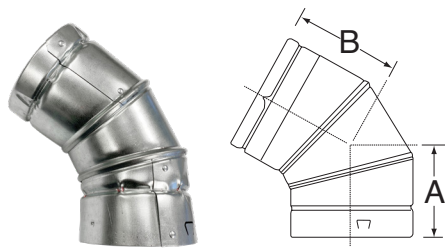

NOTE: For installation in Canada order "Azm 150" only.

Size	Product No.	Part No.	Outer	A	B
7"	107215	7RV-EL45	7-1/2"	3-3/16"	7-1/2"
7"	107220	7RV-45 - Azm 150	7-1/2"	3-3/16"	7-1/2"
8"	108215	8RV-EL45	8-1/2"	3-1/4"	8-1/2"
8"	108220	8RV-45 - Azm 150	8-1/2"	3-1/4"	8-1/2"

STANDARD TEE

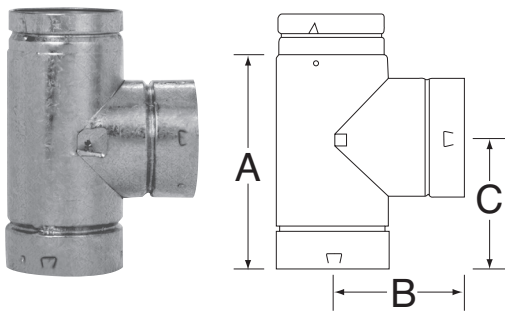

NOTE: For installation in Canada order "Azm 150" only.

- Used to transition system from horizontal to vertical orientation.
- Provides easy access for inspection and maintenance.
- Tee Cap sold separately.

Size	Product No.	Part No.	A	B	C
3"	103100	3RV-TS	6-5/8"	4-1/4"	4-1/4"
3"	103101	3RV-TS - Azm 150	6-5/8"	4-1/4"	4-1/4"
4"	104100	4RV-TS	8-1/2"	4-3/4"	5"
4"	104101	4RV-TS - Azm 150	8-1/2"	4-3/4"	5"
5"	105100	5RV-TS	9-1/2"	5-1/4"	5-1/2"
5"	105101	5RV-TS - Azm 150	9-1/2"	5-1/4"	5-1/2"
6"	106100	6RV-TS	10-1/2"	5-3/4"	6"
6"	106101	6RV-TS - Azm 150	10-1/2"	5-3/4"	6"
7"	107100	7RV-TS	11-1/2"	6-1/4"	6-1/2"
7"	107101	7RV-TS - Azm 150	11-1/2"	6-1/4"	6-1/2"
8"	108100	8RV-TS	12-1/2"	6-3/4"	7"
8"	108101	8RV-TS - Azm 150	12-1/2"	6-3/4"	7"

Elbows, Tees and Wyes continued

- Used to transition system from horizontal to vertical orientation.
- Allows small diameter pipe to be connected to the body of the tee.
- Allows connections from 2 or more appliances into the common vent.

Size	Product No.	Part No.	A	B
4" to 3"	104103	4RV-T3	8-1/2"	4-3/4"
5" to 3"	105103	5RV-T3	9-1/2"	5-1/4"
5" to 4"	105104	5RV-T4	9-1/2"	5-1/4"
6" to 3"	106103	6RV-T3	10-1/2"	5-3/4"
6" to 4"	106104	6RV-T4	10-1/2"	5-3/4"
6" to 5"	106105	6RV-T5	10-1/2"	5-3/4"
7" to 4"	107104	7RV-T4	11-1/2"	6-1/4"
7" to 5"	107105	7RV-T5	11-1/2"	6-1/4"
7" to 6"	107106	7RV-T6	11-1/2"	6-1/4"
8" to 4"	108104	8RV-T4	12-1/2"	6-3/4"
8" to 6"	108106	8RV-T6	12-1/2"	6-3/4"

REDUCTION TEE

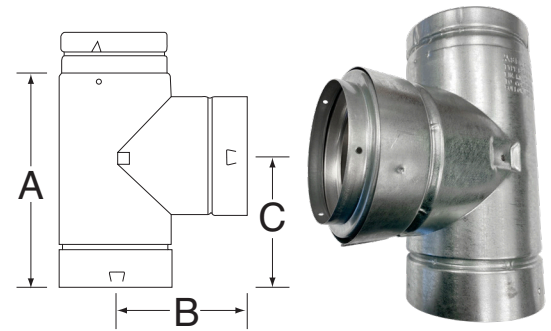

NOTE: Low Profile Double Wall In increaser included.

- Used at bottom of Tee.
- Removable for easy system maintenance.

Size	Product No.	Part No.
3"	103180	3RV-TC
4"	104180	4RV-TC
5"	105180	5RV-TC
6"	106180	6RV-TC
7"	107180	7RV-TC
8"	108180	8RV-TC

TEE CAP



- Used to transition system from horizontal to vertical orientation.
- Provides better flue gas flow than a traditional Tee.

Size	Product No.	Part No.	A	B	C	D
4" x 3"	104133	4RV-3FY	4"	4"	3"	10"
4" x 4"	104134	4RV-4FY	4"	4"	4"	10"
5" x 3"	105133	5RV-3FY	5"	5"	3"	10"
5" x 4"	105134	5RV-4FY	5"	5"	4"	10"
5" x 4" x 3"	1051343	5RV4-3FY	5"	4"	3"	11.5"
5" x 4" x 4"	1051344	5RV4-4FY	5"	4"	4"	11.5"
6" x 3"	106133	6RV-3FY	6"	6"	3"	11"
6" x 4"	106134	6RV-4FY	6"	6"	4"	11"
6" x 5"	106135	6RV-5FY	6"	6"	5"	11"

FIXED WYE

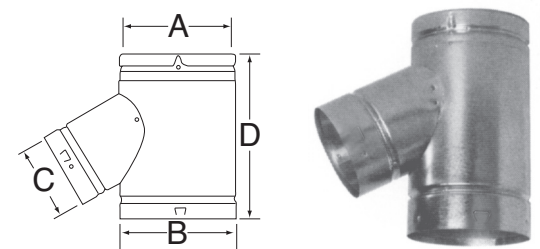

Tops, Supports And Firestops

TOP (BIRD PROOF)

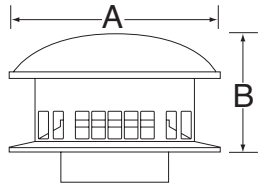

- These tops cannot be used for wood burning applications
- Helps prevent rain and debris from entering the vent.
- External screen prevents entry of most bird species.

Size	Product No.	Part No.	A	B
3"	103800	3RV-RT	6"	3-1/4"
3"	103801	3RV-RT - Canada	6"	3-1/2"
4"	104800	4RV-RT	8"	4-1/4"
4"	104801	4RV-RT - Canada	8"	4-1/4"
5"	105800	5RV-RT	10"	5-1/4"
5"	105801	5RV-RT - Canada	10"	5-1/4"
6"	106800	6RV-RT	12"	6-1/4"
6"	106801	6RV-RT - Canada	12"	6-1/4"
7"	107800	7RV-RT	14"	7-1/2"
7"	107801	7RV-RT - Canada	14"	7-1/2"
8"	108800	8RV-RT	16"	8-1/2"
8"	108801	8RV-RT - Canada	16"	8-1/2"

HI-WIND TOP

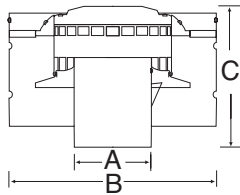

- Used in high wind environments.
- Improves flue gas flow to prevent downdrafts.

Size	Product No.	Part No.	A	B	C
3"	103802	3RV-HWT	3"	8"	5-1/2"
3"	103804	3RV-HWT - Canada	3"	8"	5-1/2"
4"	104802	4RV-HWT	4"	10"	6"
4"	104804	4RV-HWT - Canada	4"	10"	6"
5"	105802	5RV-HWT	5"	12"	7"
5"	105804	5RV-HWT - Canada	5"	12"	7"
6"	106802	6RV-HWT	6"	14"	7-1/2"
6"	106804	6RV-HWT - Canada	6"	14"	7-1/2"

UNIVERSAL VENT CAP

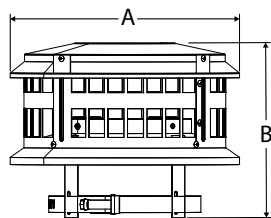

- Convenient solution for a variety of rooftop vent, flue, and B-vent installations
- Self-centering, adjustable design means a quick, easy installation
- Worm Gear Clamp with one-tool adjustability
- Three sizes fit pipes with outside diameters from 3" to 8.5"
- Helps prevent rain, debris, and most birds from entering the vent
- Aluminum construction for rust and corrosion resistance
- Includes separate instruction sheet
- Listings: UL 441 and CAN/ULC-605

Order #	Description	Fits O.D.	Case Qty	A	B
34UGVC	3"- 4" Universal Vent Cap	3" - 4.5"	6	8"	5"
56UGVC	5"- 6" Universal Vent Cap	5" - 6.5"	6	11"	7-1/2"
78UGVC	7"- 8" Universal Vent Cap	7" - 8.5"	4	15"	8-1/4"

Tops, Supports And Firestops continued

- Support Plate should be installed above the joist.
- Support Plate also serves as a firestop.
- Will support a maximum of 35' of gas vent.

Size	Product No.	Part No.	A	Plate Dim.
3"	103400	3RV-GVS	3-5/8"	17" x 10"
3"	103401	3RV-GVS - Canada	3-5/8"	17" x 10"
4"	104400	4RV-GVS	4-5/8"	17" x 10"
4"	104401	4RV-GVS - Canada	4-5/8"	17" x 10"
5"	105400	5RV-GVS	5-5/8"	17" x 12"
5"	105401	5RV-GVS - Canada	5-5/8"	17" x 12"
6"	106400	6RV-GVS	6-5/8"	17" x 12"
6"	106401	6RV-GVS - Canada	6-5/8"	17" x 12"
7"	107400	7RV-GVS	7-5/8"	17" x 14"
7"	107401	7RV-GVS - Canada	7-5/8"	17" x 14"
8"	108400	8RV-GVS	8-5/8"	17" x 14"
8"	108401	8RV-GVS - Canada	8-5/8"	17" x 14"

Size	Product No.	Part No.	A
3"	103402	3RV-GVSB	3-5/8"
4"	104402	4RV-GVSB	4-5/8"
5"	105402	5RV-GVSB	5-5/8"
6"	106402	6RV-GVSB	6-5/8"
7"	107402	7RV-GVSB	7-5/8"

- Used to ensure clearance to combustibles is maintained.
- Wall Thimble also serves as a firestop.
- Adjusts from 4 - 1/8" to 7" to fit thickness of wall.

Size	Product No.	Part No.	A	B
3"	187703	3RV-WT	3-5/8"	7"
4"	187704	4RV-WT	4-5/8"	8-1/4"
5"	187705	5RV-WT	5-5/8"	9-1/2"
6"	187706	6RV-WT	6-5/8"	10-3/4"
7"	187707	7RV-WT	7-5/8"	11"
8"	187708	8RV-WT	8-5/8"	12-1/2"

- Used to support and stabilize the pipe against a wall.
- Will support up to 35'

Size	Product No.	Part No.	A
3"	103430	3RV-WS/B	3-5/8"
4"	104430	4RV-WS/B	4-5/8"
5"	105430	5RV-WS/B	5-5/8"
6"	106430	6RV-WS/B	6-5/8"
7"	107430	7RV-WS/B	7-5/8"
8"	108430	8RV-WS/B	8-5/8"

SUPPORT ASSEMBLY

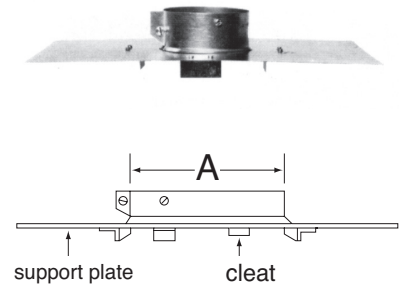

GAS VENT SUPPORT COLLAR & HARDWARE

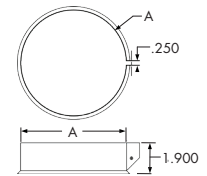

WALL THIMBLE

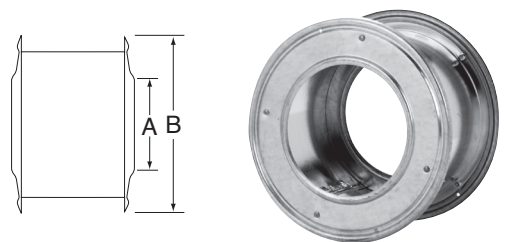

WALL SUPPORT/BAND ASSEMBLY

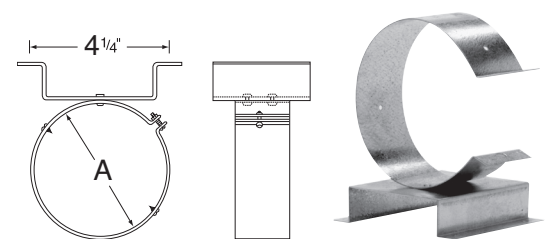

Tops, Supports And Firestops continued

WALL BAND

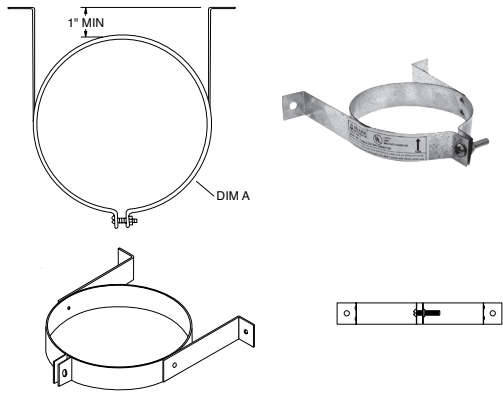

- Used to stabilize the pipe against a wall.
- Must be installed just above the Tee and every 6' thereafter

Size	Product No.	Part No.	A
3"	103431	3RV-WB	3-1/2" min
4"	104431	4RV-WB	4-1/2" min
5"	105431	5RV-WB	5-1/2" min

GAS VENT FIRESTOP SPACER

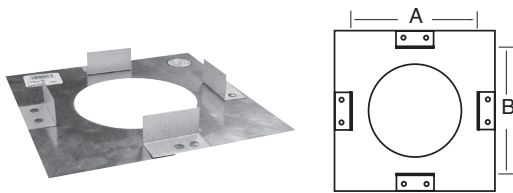

- Used to protect combustible materials where pipe passes through a ceiling or wall
- Extended bottom flange

Size	Product No.	Part No.	A	B
3"	103461	3RV-FS	5-1/2"	5-1/2"
4"	104461	4RV-FS	6-1/2"	6-1/2"
5"	105461	5RV-FS	7-1/2"	7-1/2"
6"	106461	6RV-FS	8-1/2"	8-1/2"
7"	107461	7RV-FS	9-1/2"	9-1/2"
8"	108461	8RV-FS	10-1/2"	10-1/2"

QUICK GRIP FIRESTOP/SUPPORT

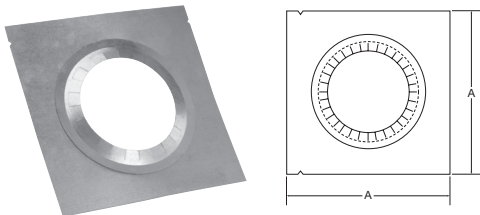

NOTE: In Canada use only UL-listed model.

- Used to support and protect combustible materials where the pipe passes through a ceiling

Size	Product No.	Part No.	A
3"	103406	3RV-FSP	9"
4"	104406	4RV-FSP	10"
5"	105406	5RV-FSP	11"
6"	106406	6RV-FSP	12"

QUICK GRIP FIRESTOP/SUPPORT - UL MODEL

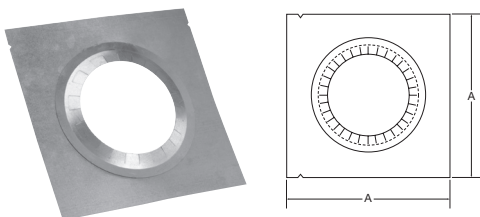

NOTE: UL-listed model includes an attached spacer ring to ensure 1" clearance to combustibles. In Canada use only UL-listed model.

- Used to support and protect combustible materials where the pipe passes through a ceiling

Size	Product No.	Part No.	A
3"	103404	3RV-FSPU	9"
4"	104404	4RV-FSPU	10"
5"	105404	5RV-FSPU	11"
6"	106404	6RV-FSPU	12"

Flashings and Storm Collars

- Provides a decorative/finished appearance.

Size	Product No.	Part No.	A	B	C
3"	103460	3RV-GC	3-5/8"	10-11/16"	3-9/16"
4"	104460	4RV-GC	4-5/8"	10-11/16"	3-1/16"
5"	105460	5RV-GC	5-5/8"	10-11/16"	2-9/16"
6"	106460	6RV-GC	6-5/8"	10-11/16"	2-1/16"
7"	107460	7RV-GC	7-5/8"	11-1/4"	1-3/4"

PIPE COLLAR

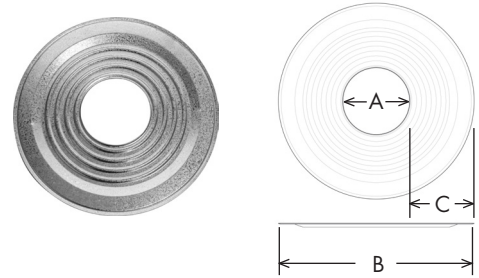

- Used where the vent passes through a roof.

Size	Product No.	Part No.	A	B	C	D
3"	103825	3RV-AF	3-1/2"	14-7/8"	12-1/4"	6-11/16"
4"	104825	4RV-AF	4-1/2"	16"	13-1/4"	7-3/4"
5"	105825	5RV-AF	5-1/2"	16-15/16"	14-1/4"	8-7/8"
6"	106825	6RV-AF	6-1/2"	18"	15-1/4"	10"
7"	107825	7RV-AF	7-1/2"	19-1/8"	16"	11-1/8"
8"	108825	8RV-AF	8-1/2"	20-1/4"	16-15/16"	12-1/4"

ADJUSTABLE ROOF FLASHING - FLAT TO 6/12

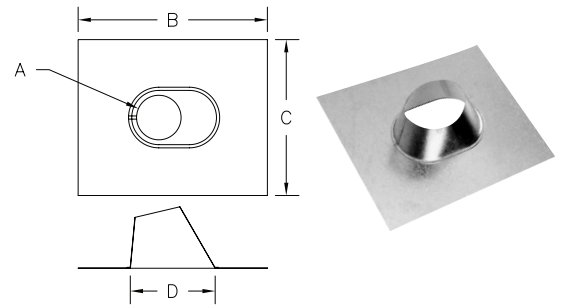

- Used where the vent passes through a roof.

Size	Product No.	Part No.	A	B	C	D
3"	103830	3RV-AF12	3-1/2"	18"	15-1/4"	10-1/4"
4"	104830	4RV-AF12	4-1/2"	19-1/8"	16"	11-1/8"
5"	105830	5RV-AF12	5-1/2"	20-1/4"	16-15/16"	12-1/4"
6"	106830	6RV-AF12	6-1/2"	24-1/4"	20"	15-5/8"
7"	107830	7RV-AF12	7-1/2"	24-1/4"	20"	15-5/8"
8"	108830	8RV-AF12	8-1/2"	25"	19-1/2"	17-1/8"

ADJUSTABLE ROOF FLASHING 6/12 TO 12/12

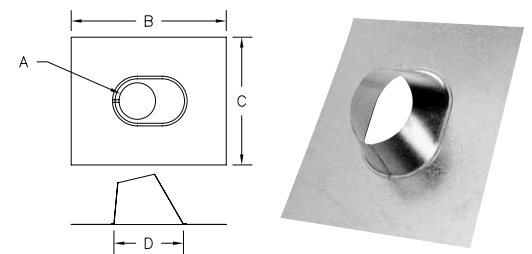

- Used where the vent passes through a roof.
- Adjustable to 6/12 pitch

Size	Product No.	Part No.	A	B	C
3"	103820	3RV-TFA	8-3/4"	11"	19-1/2"
4"	104820	4RV-TFA	8-3/4"	11"	19-1/2"
5"	105820	5RV-TFA	8-3/4"	11"	19-1/2"
6"	106820	6RV-TFA	8-3/4"	11"	19-1/2"
7"	107820	7RV-TFA	8-3/4"	14"	22"
8"	108820	8RV-TFA	8-1/4"	15-3/16"	23"

TALL CONE ADJUSTABLE ROOF FLASHING

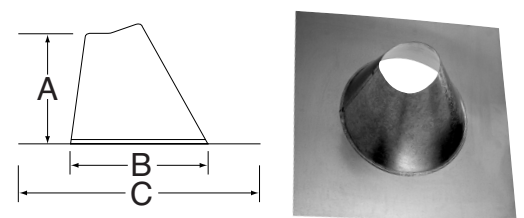

Flashings and Storm Collars continued

TALL CONE FLAT ROOF FLASHING

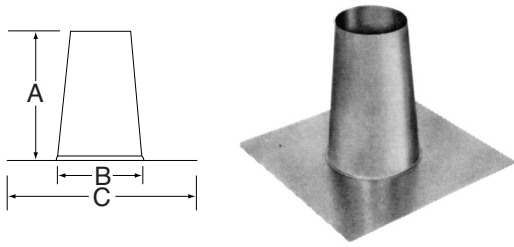

- Used on flat roof surfaces.

Size	Product No.	Part No.	A	B	C
3"	103815	3RV-TF	12"	7-1/2"	16-1/2"
4"	104815	4RV-TF	12"	7-1/2"	16-1/2"
5"	105815	5RV-TF	12"	7-1/2"	16-1/2"
6"	106815	6RV-TF	12"	11"	19-1/2"
7"	107815	7RV-TF	12"	11"	19-1/2"
8"	108815	8RV-TF	12"	11"	19-1/2"

STORM COLLAR

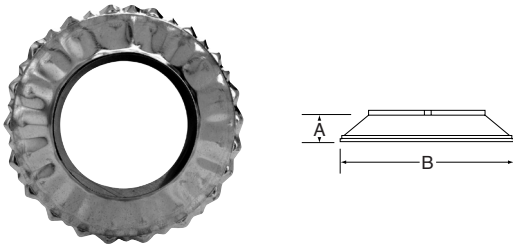

- Used to provide a weather proof seal to pipe above roof line.
- Used above the Flashing.
- Seal inner edge with hi-temp silicone sealant.

Size	Product No.	Part No.	A	B
3"	103810	3RV-SC	1-9/16"	6-5/8"
4"	104810	4RV-SC	1-9/16"	7-5/8"
5"	105810	5RV-SC	1-9/16"	8-5/8"
6"	106810	6RV-SC	1-9/16"	9-5/8"
7"	107810	7RV-SC	1-9/16"	10-3/4"
8"	108810	8RV-SC	1-9/16"	11-3/4"

NOTE: See instructions for use/limitations

Termination Kit

RV TERMINATION KIT (USA ONLY)



- For terminating vertically in most common installations
- Includes: Round Top, Flashing Flat to 6/12, Storm Collar, and Draft Hood Connector.

Size	Product No.	Part No.
3"	183600	3RV-TK
4"	184600	4RV-TK
5"	185600	5RV-TK
6"	186600	6RV-TK

* Does not include pipe length.

Adapters, Connectors And Increases

- Connects single wall Vent to B Vent.
- Used to connect pipe to draft hood at appliance.

Size	Product No.	Part No.	Length
3"	103240	3RV-DH	4-1/2"
3"	103241	3RV-DH - Azm 150	4-1/2"
4"	104240	4RV-DH	4-1/2"
4"	104241	4RV-DH - Azm 150	4-1/2"
5"	105240	5RV-DH	4-1/2"
5"	105241	5RV-DH - Azm 150	4-1/2"
6"	106240	6RV-DH	4-1/2"
6"	106241	6RV-DH - Azm 150	4-1/2"
7"	107240	7RV-DH	7"
7"	107241	7RV-DH - Azm 150	7"
8"	108240	8RV-DH	8"
8"	108241	8RV-DH - Azm 150	8"

DRAFT HOOD CONNECTOR

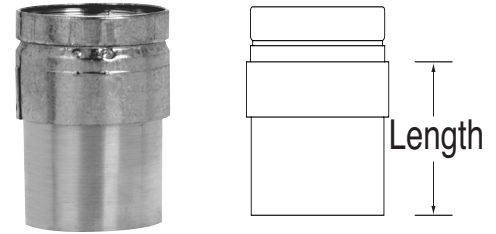

NOTE: For installation in Canada order "Azm 150" only.

- Connects B Vent to C Vent.
- Used to connect pipe to single wall.

Size	Product No.	Part No.	A	B
3"	103242	3RV-REV-DH	3.51"	2.95"
4"	104242	4RV-REV-DH	4.51"	3.95"
5"	105242	5RV-REV-DH	5.51"	4.95"
6"	106242	6RV-REV-DH	6.51"	5.95"
7"	107242	7RV-REV-DH	7.51"	6.95"
8"	108242	8RV-REV-DH	8.51"	7.95"

REVERSE DRAFT HOOD CONNECTOR

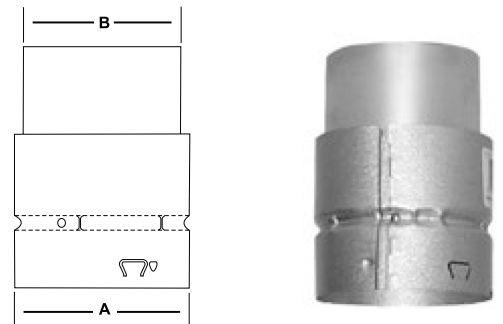

- Connects single wall Vent to B Vent.
- Used to connect pipe to draft hood at appliance.

Size	Product No.	Part No.	Length
4"	104243	4RV-DHCL	5"

DRAFT HOOD CONNECTOR LONG (USA ONLY)

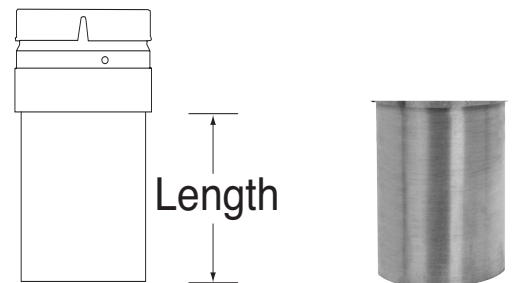

Adapters, Connectors And Increases continued

UNIVERSAL ADAPTER - MALE 1/4"

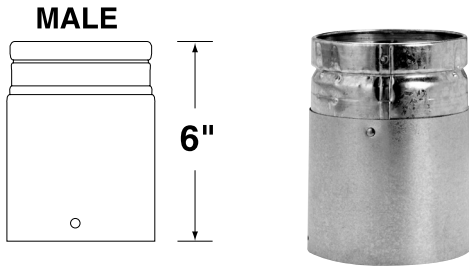

NOTE: Male adapter used to adapt to Selkirk pipe toward termination.

NOTE: For installation in Canada order "Azm 150" only.

- Used to connect B Vent to/from 1/4" Type B Gas Vent
- Allows Selkirk B Vent to be used in conjunction with other brands of existing vent.

Size	Product No.	Part No.
3"	103079	3RV-UAM - Azm 150
3"	103081	3RV-UAM
4"	104079	4RV-UAM - Azm 150
4"	104081	4RV-UAM
5"	105079	5RV-UAM - Azm 150
5"	105081	5RV-UAM
6"	106079	6RV-UAM - Azm 150
6"	106081	6RV-UAM
7"	107079	7RV-UAM - Azm 150
7"	107081	7RV-UAM
8"	108079	8RV-UAM - Azm 150
8"	108081	8RV-UAM

UNIVERSAL ADAPTER - FEMALE 1/4"

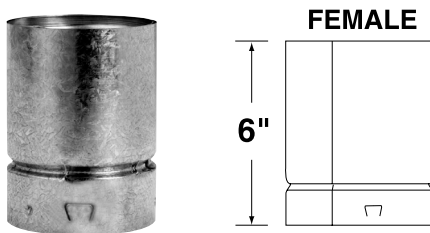

NOTE: Female adapter used to adapt to Selkirk pipe toward appliance.

NOTE: For installation in Canada order "Azm 150" only.

- Used to connect B Vent to/from 1/4" Type B Gas Vent
- Allows Selkirk B Vent to be used in conjunction with other brands of existing vent.

Size	Product No.	Part No.
3"	103078	3RV-UAF - Azm 150
3"	103080	3RV-UAF
4"	104078	4RV-UAF - Azm 150
4"	104080	4RV-UAF
5"	105078	5RV-UAF - Azm 150
5"	105080	5RV-UAF
6"	106078	6RV-UAF - Azm 150
6"	106080	6RV-UAF
7"	107078	7RV-UAF - Azm 150
7"	107080	7RV-UAF
8"	108078	8RV-UAF - Azm 150
8"	108080	8RV-UAF

UNIVERSAL ADAPTER - MALE 1/2"

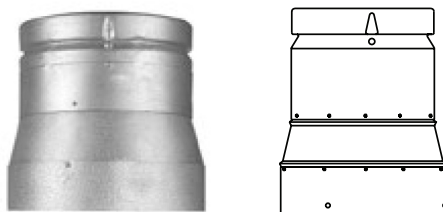

NOTE: Male adapter used to adapt to Selkirk pipe toward termination.

- Used to connect B Vent from 1/2" male to 1/4" female Type B Gas Vent
- Allows Selkirk B Vent to be used in conjunction with other brands of existing vent.

Size	Product No.	Part No.
4"	104077	4RV-UAM.5
5"	105077	5RV-UAM.5
6"	106077	6RV-UAM.5

Adapters, Connectors And Increases continued

Model RV Type B Gas Vent

- Used to connect B Vent from 1/2" female to 1/4" male Type B Gas Vent
- Allows Selkirk B Vent to be used in conjunction with other brands of existing vent.

Size	Product No.	Part No.
4"	104076	4RV-UAF.5
5"	105076	5RV-UAF.5
6"	106076	6RV-UAF.5

- Increase 3" to 4" only.

Size	Product No.	Part No.
3" x 4"	103244	3RV-AI4
3" x 4"	104248*	4RV-3RA

- Used to increase pipe diameter.

	Size	Product No.	Part No.
3"	3" x 4"	103324	3RV-I4DW
3"	3" x 5"	103325	3RV-I5DW
4"	4" x 5"	104325	4RV-I5DW
4"	4" x 6"	104326	4RV-I6DW
5"	5" x 6"	105326	5RV-I6DW

- Used to increase pipe diameter
- Used for tight installations to optimize space.

	Size	Product No.	Part No.
3"	3" x 4"	103304	3RV-I4
3"	3" x 5"	103305	3RV-I5
3"	3" x 6"	103306	3RV-I6
3"	3" x 7"	103307	3RV-I7
3"	3" x 8"	103308	3RV-I8
4"	4" x 5"	104305	4RV-I5
4"	4" x 6"	104306	4RV-I6
4"	4" x 7"	104307	4RV-I7
4"	4" x 8"	104308	4RV-I8
5"	5" x 6"	105306	5RV-I6
5"	5" x 7"	105307	5RV-I7
5"	5" x 8"	105308	5RV-I8
6"	6" x 7"	106307	6RV-I7
6"	6" x 8"	106308	6RV-I8
7"	7" x 8"	107308	7RV-I8
8"	8" x 10"	108310	8RV-I10

UNIVERSAL ADAPTER - FEMALE 1/2"

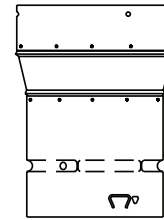

NOTE: Female adapter used to adapt to Selkirk pipe toward the appliance

APPLIANCE INCREASES (USA ONLY)

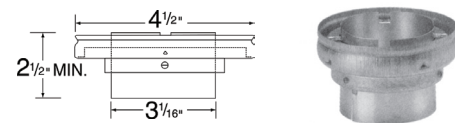

* Only for use with Rheem / Ruud Appliances

DOUBLE WALL INCREASER

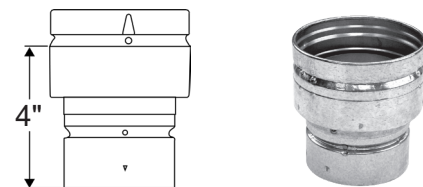

LOW PROFILE DOUBLE WALL INCREASER

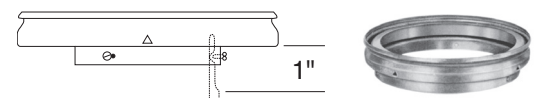

NOTE: Other sizes available for project work on special order.
Allow 30 working days after placing order.
Maximum screw size 3/8".

Adapters, Connectors And Increases continued

REDUCER (USA ONLY)

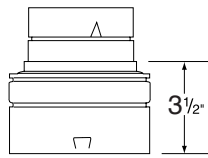

Size	Product No.	Part No.	1 Step
4"	104363	4RV-R3	4" x 3"
5"	105364	5RV-R4	5" x 4"
6"	106365	6RV-R5	6" x 5"
7"	107366	7RV-R6	7" x 6"
8"	108367	8RV-R7	8" x 7"

NOTE: One step only

ATTIC INSULATION SHIELD

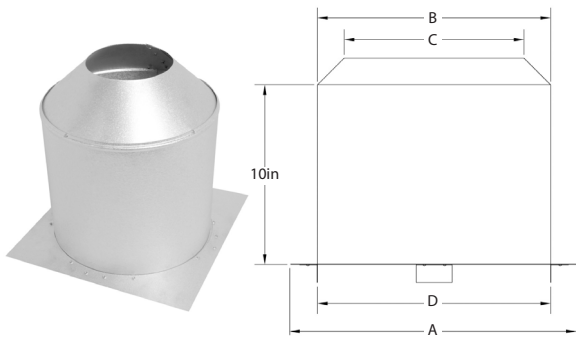

- The AIS must be installed where the pipe enters the attic space in any installation.
- Designed to keep insulation away from the pipe and to maintain the mandatory 1" clearance to combustibles.

Size	A	B	C	D	Product No.	Pack
3"	7-1/2"	5-1/2"	3-19/32"	5-1/2"	103490	1
4"	8-1/2"	6-1/2"	4-19/32"	6-1/2"	104490	1
5"	9-1/2"	7-1/2"	5-19/32"	7-1/2"	105490	1
6"	10-1/2"	8-1/2"	6-19/32"	8-1/2"	106490	1
7"	11-1/2"	9-1/2"	7-19/32"	9-1/2"	107490	1
8"	12-1/2"	10-1/2"	8-19/32"	10-1/2"	108490	1

Oval Vent Pipe

OVAL PIPE - 4", 5", 6" (USA ONLY)

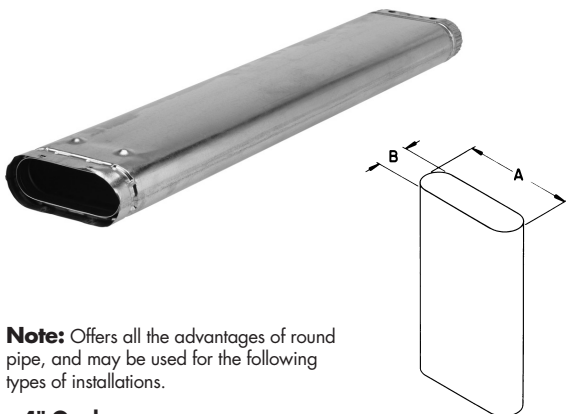

Note: Offers all the advantages of round pipe, and may be used for the following types of installations.

4" Oval:

- Conventional Type B
- Type B-2x4 when used with firestop
- Type BW-2x4 with recessed heater

5" Oval:

- Type B
- Type B-2x4

6" Oval:

- Type B-2x6

Diameter	Length	A	B	Product No.	Part No.
4"	6	7-1/16"	2-7/8"	164006	4OV-06
4"	12	7-1/16"	2-7/8"	164012	4OV12
4"	18	7-1/16"	2-7/8"	164018	4OV18
4"	24	7-1/16"	2-7/8"	164024	4OV24
4"	36	7-1/16"	2-7/8"	164036	4OV36
4"	48	7-1/16"	2-7/8"	164048	4OV48
4"	60	7-1/16"	2-7/8"	164060	4OV60
5"					
5"	6	10-3/4"	2-7/8"	165006	5OV-06
5"	12	10-3/4"	2-7/8"	165012	5OV12
5"	18	10-3/4"	2-7/8"	165018	5OV18
5"	24	10-3/4"	2-7/8"	165024	5OV24
5"	36	10-3/4"	2-7/8"	165036	5OV36
5"	48	10-3/4"	2-7/8"	165048	5OV48
5"	60	10-3/4"	2-7/8"	165060	5OV60
6"					
6"	6	11-1/2"	3-1/4"	166006	6OV-06
6"	12	11-1/2"	3-1/4"	166012	6OV12
6"	18	11-1/2"	3-1/4"	166018	6OV18
6"	24	11-1/2"	3-1/4"	166024	6OV24
6"	36	11-1/2"	3-1/4"	166036	6OV36

Oval Vent Pipe continued

- The adjustable length overlaps the standard pipe section to permit adjustments from 3" to 10".

Size	Product No.	Part No.
4"	164082	40V-AJ
5"	165082	50V-AJ
6"	166082	60V-AJ

ADJUSTABLE OVAL PIPE (USA ONLY)



Oval Elbows, Tees And Wyes

- The standard 45° elbow is used in pairs where offsets are desired in 1" minimum clearance enclosures or open spaces, such as attics or basements. Add pipe sections between pairs to produce additional offset.

Size	Product No.	Part No.	A	B
4"	164215	4OV-45S	3"	3"
5"	165215	5OV-45S	3 1/2"	3 1/2"
6"	166215	6OV-45S	4"	4"

45° OVAL ELBOW (USA ONLY)

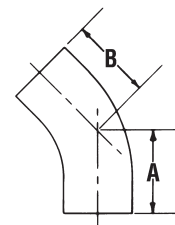

- The flat 45° elbow is used in pairs where offsets are desired in 1" minimum clearance enclosures or open spaces, such as attics or basements. Add pipe sections between pairs to produce additional offset.

Size	Product No.	Part No.	A	B
4"	164220	4OV-45F	3-3/4"	3-3/4"
5"	165220	5OV-45F	4-3/4"	4-3/4"
6"	166220	6OV-45F	5"	5"

45° OVAL ELBOW - FLAT (USA ONLY)

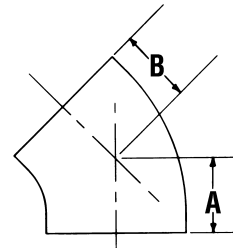

- The branch size and trunk size have the same diameter. The tee branch accepts either double- or single-wall pipe.

Size	Product No.	Part No.	A	B	C
4"	164100	4OV-TS	12"	2-9/16"	2-3/8"
5"	165100	5OV-TS	12"	2-9/16"	2-3/8"
6"	166100	6OV-TS	12"	2-5/8"	2-3/4"

STANDARD OVAL TEE (USA ONLY)

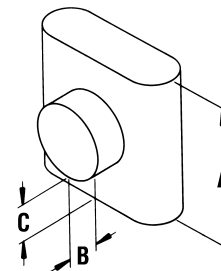

- The tee cap is used for closing off the bottom of the tee.

Size	Product No.	Part No.
4"	164180	4OV-TC
5"	165180	5OV-TC
6"	166180	6OV-TC

STANDARD OVAL TEE CAP (USA ONLY)



Oval Tops, Supports And Firestops

4" OVAL TOP (USA ONLY)

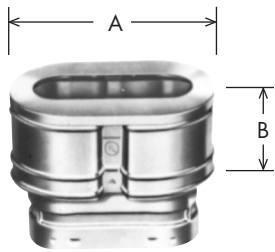

Size	Product No.	Part No.	A	B
4"	164800	4OV-OT	5-3/8" x 8-1/2"	3-1/2"

NOTE: For 5OV and 6OV Tops, use Oval to Round Adapters in conjunction with standard RV Round Tops.

OVAL VENT KIT



- The kit includes: 2 - 4OV-24, 4OV-BP, 4OV-CS, 4OV-RV4

Size	Product No.	Part No.
4"	164620	4OV-VK

OVAL TEE SUPPORT (USA ONLY)

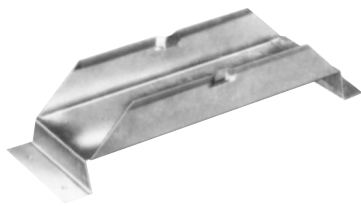

- The tee support is used to support and center the tee. Use with the tee cap shown above

Size	Product No.	Part No.
4"	164430	4OV-ST
5"	165430	5OV-ST
6"	166430	6OV-ST

OVAL FIRESTOP SPACERS (USA ONLY)

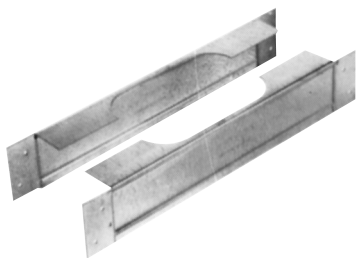

- The firestop spacers center vent in 16" O.C. stud space and serve as a firestop at the ceiling level. This is a required component for Type B 2 x 4 and multi-story Type BW installations.

Size	Product No.	Part No.	Wall
4"	164460	4OV-FS	2" x 4"
5"	165460	5OV-FS	2" x 4"
4"	164465	4OV-FS6	2" x 6"
5"	165465	5OV-FS6	2" x 6"
6"	166460	6OV-FS	2" x 6"

TYPE BW HOLD-DOWN PLATE (USA ONLY)

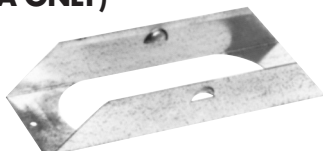

- The Type BW hold-down plate is required for connecting Type BW vent to a wall furnace outlet.

Size	Product No.	Part No.
4"	164410	4OV-BP

Oval Tops, Supports And Firestops continued

- Type BW plate spacers are required at the first ceiling level above a wall furnace to center and space vent properly and to provide the required opening between floors. Firestop spacers must be used at subsequent levels.

Size	Product No.	Part No.
4"	164520	40V-CS

- The Type BW attic shield is used on a single-story AVS building or on the top story of a multi-story building for Type BW gas vent.
- A 26-gauge galvanized sleeve should extend from the top of the ceiling plate into the attic.
- A Type BW attic shield is required by Los Angeles Code and UMC.

Size	Product No.	Part No.
4"	164490	40V-AS

- The Type BW installation kit contains one pair of Type BW Plate Spacers (40V-CS) and one BW Hold Down Plate (40V-BP).

Size	Product No.	Part No.
4"	164607	40V-BW

TYPE BW PLATE SPACERS (USA ONLY)

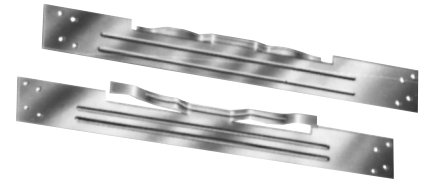

TYPE BW ATTIC SHIELD (USA ONLY)

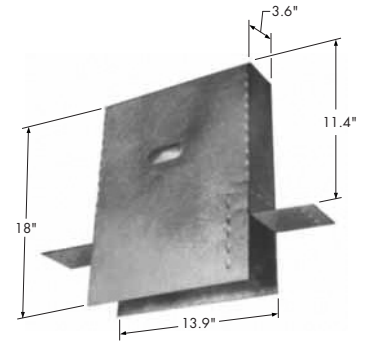

TYPE BW INSTALL KIT

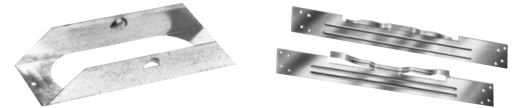

Flashings and Storm Collar

- The flashing is installed either parallel or perpendicular to the roof ridge, and fits roof pitches flat to 5/12.

Size	Product No.	Part No.
4"	164825	40V-AF
5"	165825	50V-AF
6"	166825	60V-AF

PITCH FLASHING - FLAT TO 5/12 (USA ONLY)

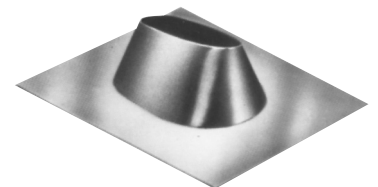

- The storm collar serves as a counter flashing and requires mastic to seal to the vent pipe.

Size	Product No.	Part No.
4"	164810	40V-SC
5"	165810	50V-SC
6"	166810	60V-SC

OVAL STORM COLLAR (USA ONLY)



Oval Adapters, Connectors and Increases

ROUND TO OVAL ADAPTER (USA ONLY)

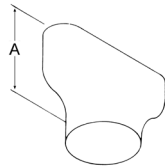

- The round-to-oval adapter is used for conversion of vent from round to oval.

Size	Product No.	Part No.	A
4"	164370	4RV-OV4	6-7/8"
5"	165370	5RV-OV5	9-3/8"
6"	166370	6RV-OV6	10-3/4"

OVAL TO ROUND ADAPTER

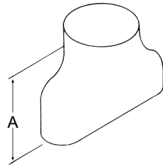

- The oval-to-round adapter is used for conversion of vent from oval to round.

Size	Product No.	Part No.	A
4"	164380	4OV-RV4	6-7/8"
5"	165380	5OV-RV5	9-3/8"
6"	166380	6OV-RV6	10-3/4"

NOTE: Only 4" is available in Canada

4" OVAL INCREASER TO 5" (USA ONLY)



- The increaser permits increasing of vent from 4" oval to 5" oval

Size	Product No.	Part No.
4"	164930	4OV-5OV

DWC Double Wall Flexible Gas Vent Pipe

DWC 3" through 5"

Selkirk DWC Double Wall Flexible Gas Vent pipe is available in 3", 4", & 5" diameters in 2', 3', 4', & 5' lengths designed for easy connection to standard Type B Gas Vent. DWC is listed for use as a "segment" of an unenclosed Type B gas vent system and is fully safety certified for use in conditioned and/or unconditioned attics and crawl spaces (US Only). DWC can simplify alignment of most installations by enabling a quick and easy offset between sections of rigid gas vent.

Size	Product No.	Part No.
3"	1730022	3DWC - 2'
3"	1730033	3DWC - 3'
3"	1730044	3DWC - 4'
3"	1730066	3DWC - 5'
3"	1734300	3DWC - SS
4"		
4"	1740022	4DWC - 2'
4"	1740033	4DWC - 3'
4"	1740044	4DWC - 4'
4"	1740066	4DWC - 5'
4"	1744300	4DWC - SS
5"		
5"	1750022	5DWC - 2'
5"	1750033	5DWC - 3'
5"	1750044	5DWC - 4'
5"	1750066	5DWC - 5'
5"	1754300	5DWC - SS

DOUBLE WALL FLEXIBLE B-VENT



NOTE: SS = Support Spacer
Support Spacer not available in Canada

EFC 3" through 4"

The Selkirk Model EFC Expandable Flexible Gas Vent Connector is designed for use with gas-fired appliances equipped with draft hoods and other appliances listed for use with Type B Gas Vent. This Model EFC Expandable Flexible Gas Vent Connector system eliminates the need for elbows and greatly simplifies most gas appliance vent installations. The Model EFC is available in 3" & 4" diameters and can expand from 2 feet to 3 1/2 feet or 2 1/2 feet to 5 feet. Ask your sales associate for details.

Size	Product No.	Part No.	Description
3"	173036	3EFC-3	3" (2'-3.5') Flex Connector
3"	173060	3EFC-5	3" (2.5'-5') Flex Connector
4"			
4"	174036	4EFC-3	4" (2'-3.5') Flex Connector
4"	174061	4EFC-5	4" (2.5'-5') Flex Connector

EXPANDABLE FLEXIBLE GAS VENT CONNECTOR



Gas Appliance Chimney Liner Systems

FLEXI BASIC KIT



- Available in 3", 4", 5", 5.5", 6", 7" and 8" diameters
- Available in 15', 25' and 35' lengths
- Listed to: UL1777 and ULC-S635
- Compatible with Type B gas vent systems
- Kit includes length, round top, flashing with 3" collar, mortar guard, fasteners and instructions

AF*-FC Flexi Coupler is available to assist in joining flexible lengths or connecting to fittings.

AF*-BVA Type B Gas Vent Adapter is available to transition from Type B Gas Vent to Flexi Chimney Liner.

Size	Length	Product No.	Part No.	Pack
3"	15'	1730015	AF15-03	1
4"	15'	1740015	AF15-04	1
5"	15'	1750015	AF15-05	1
25' Lengths				
3"	25'	1730025	AF25-03	1
4"	25'	1740025	AF25-04	1
5"	25'	1750025	AF25-05	1
5.5"	25'	1755025	AF25-05.5	1
6"	25'	1760025	AF25-06	1
7"	25'	1770025	AF25-07	1
8"	25'	1780025	AF25-08	1
35' Lengths				
3"	35'	1730035	AF35-03	1
4"	35'	1740035	AF35-04	1
5"	35'	1750035	AF35-05	1
5.5"	35'	1755035	AF35-05.5	1
6"	35'	1760035	AF35-06	1
7"	35'	1770035	AF35-07	1
8"	35'	1780035	AF35-08	1

FLEXI-LINER

Model RV Type B Gas Vent

Gas Appliance Chimney Liner Systems continued

- 10', 25' and 35' flexible liner lengths.
- Includes coupler and fastener package.
- UL-listed.

Size	Length	Product No.	Part No.	Pack
3"	10'	1730010	AFE10-03	1
4"	10'	1740010	AFE10-04	1
5"	10'	1750010	AFE10-05	1
5.5"	10'	1755010	AFE10-05.5	1
6"	10'	1760010	AFE10-06	1
7"	10'	1770010	AFE10-07	1
8"	10'	1780010	AFE10-08	1
25'				
3"	25'	1730250	AF3-25L	1
4"	25'	1740250	AF4-25L	1
5"	25'	1750250	AF5-25L	1
6"	25'	1760250	AF6-25L	1
7"	25'	1770250	AF7-25L	1
8"	25'	1780250	AF8-25L	1
35'				
3"	35'	1730350	AF3-35L	1
4"	35'	1740350	AF4-35L	1
5"	35'	1750350	AF5-35L	1
6"	35'	1760350	AF6-35L	1
7"	35'	1770350	AF7-35L	1
8"	35'	1780350	AF8-35L	1

FLEXI EXTENSION KIT



- For fitting or joining Flexi-Liner lengths

Size	A	B	Product No.	Part No.	Pack
3"	4"	2.97"	173085	AF3-FC	1
4"	4"	3.97"	174085	AF4-FC	1
5"	4"	4.97"	175085	AF5-FC	1
5.5"	4"	5.47"	175585	AF55-FC	1
6"	4"	5.97"	176085	AF6-FC	1
7"	4"	6.97"	177085	AF7-FC	1
8"	4"	7.97"	178085	AF8-FC	1

FLEX COUPLER

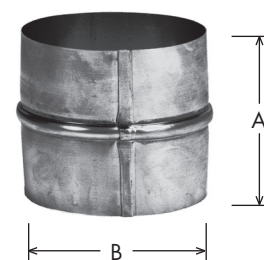

- Used to stretch and lead Flexi-Liner down chimneys

Size	Product No.	Part No.	Pack
3"	173000	FX3-PD	6
4"	174000	FX4-PD	6
5"	175000	FX5-PD	6
5.5"	175500	FX55-PD	6
6"	176000	FX6-PD	6
7"	177000	FX7-PD	6
8"	178000	FX8-PD	6

PULL DOWN



Gas Appliance Chimney Liner Systems continued

ADAPTERS

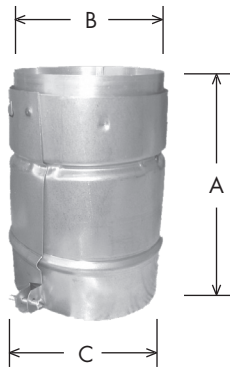

- Adapter to transition from all brands of listed Type B Gas Vent to Flexi-Liner

Size	A	B	C	Product No.	Part No.	Pack
3"	5.88"	2.95"	3.57"	173086	AF3-BVA	6
4"	5.88"	3.95"	4.57"	174086	AF4-BVA	6
5"	5.88"	4.95"	5.57"	175086	AF5-BVA	6
6"	5.88"	5.95"	6.57"	176086	AF6-BVA	6
7"	5.88"	6.95"	7.57"	177086	AF7-BVA	6
8"	5.88"	7.95"	8.57"	178086	AF8-BVA	6

FLEXI INSULATED SLEEVE



- Insulation sleeve with tough poly exterior.
- Cable ties included

Size	Product No.	Part No.	Pack
3"- 4"	1740120	AF4-FS	5
5"	1750120	AF5-FS	5
5.5" - 6"	1760120	AF6-FS	5
7"	1770210	AF7-FS	5
8"	1780210	AF8-FS	5

Submittal Specifications (USA ONLY)

SUBMITTAL SPECIFICATIONS FOR FACTORY-BUILT TYPE B GAS VENT (USA ONLY)

- TYPE: Factory-built double-wall gas vent
- APPLICATION: For venting negative pressure gas-burning appliances certified for use with Type B Gas Vent as described in NFPA 211, NFPA 54 and/or the International Fuel Gas Code.
- SIZES: 3" diameter through 8" diameter (nominal inside diameter)

Size (I.D.)	Component	Thickness	Component	Thickness
3"- 8"	Inner Liner	.012"	Outer Wall	.018"
4"	Oval Inner Liner	.012"	Outer Wall	.018"
5"-6"	Oval Inner Liner	.016"	Outer Wall	.018"

Inside Dimension	Outside Dimension	Clearance
3" through 8" (Round, 1" increments)	Inside Diameter + ½"	1"
4" Oval (2" x 6 ¾") *	Inside Dimension + ½"	1" **
5" Oval (2" x 10 ¼") *	Inside Dimension + ½"	1" **
6" Oval (2 13/16" x 11 1/8") *	Inside Dimension + ½"	1" **

*Given measurements are the major oval dimensions. 4" & 5" Oval vent can be installed within 2"x 4" stud walls; 5" & 6" Oval can be installed within 2"x 6" stud walls.

** Proper clearance in a stud wall is the distance created by centering the vent within the stud wall and will be less than one inch. The size referenced for oval vent corresponds to the diameter of a round vent of equivalent area. See full catalog for component dimensions.

Material

Inner Liner of Aluminum Alloy 1100, 3003, 3104, 3105 or 5010
Outer Wall of UL Recognized G90 Galvanized Steel

- INSULATION: Airspace between inner and outer pipe.
- UNDERWRITERS LABORATORIES, INC. LISTED: Per UL Standard UL441 (Latest Edition).
- FUEL TYPE: For use with Natural Gas, Propane or L.P. Gas Only

Job Name: _____
 Location: _____
 Architect: _____
 Engineer: _____
 Contractor: _____

Submitted By: _____ Date: _____
Selkirk Corporation Type B Gas Vent Specification
 Model RV: 3" – 8" diameter round vent
 Model OV: 4" – 6" equivalent diameter oval vent

Selkirk Corporation
 5030 Corporate Exchange Blvd.
 Grand Rapids, MI 49512
 Toll Free: 1.800.433.6341



BUILD FOR THE FUTURE

Customer Service and Support:

Airmate (USA).....	800.992.8368
Airmate (CAN)	888.735.5475
Ameriflow	800.252.8467
Amerivent (Retail).....	800.252.8467
Amerivent (Hearth & Wholesale)	800.423.4270
Amerivent (Support).....	800.748.0392
AMPCO (USA)	800.669.3269
AMPCO (CAN).....	888.735.5475
Duravent	800.835.4429
Hart & Cooley.....	800.433.6341
Hart & Cooley (Support)	800.748.0392
Heatfab (USA).....	800.772.0739
Heatfab (CAN)	800.848.2149
Lima.....	800.423.4270
Milcor	800.774.5240
Portals Plus.....	800.774.5240
RPS.....	800.624.8642
Security Chimney (USA).....	800.361.4909
Security Chimney (CAN)	800.667.3387
Selkirk (USA) Residential	800.992.8368
Selkirk (USA) Commercial.....	800.848.2149
Selkirk (USA) Support.....	800.748.0392
Selkirk (CAN)	888.735.5475

Manufacturing & Distribution Centers:

CANADA	
Nobel, ON	Manufacturing
Laval, QC	Manufacturing
Prescott, ON	Distribution
USA	
Grand Rapids, MI	Center of Excellence
Dallas, TX	Distribution
Englewood, OH	Distribution
Huntsville, AL	Manufacturing & Distribution
Mira Loma, CA	Distribution
Nampa, ID	Manufacturing & Distribution
Turner Falls, MA	Manufacturing & Distribution
Vacaville, CA	Manufacturing
MEXICO	
Ojinaga, MX	Manufacturing
Mexicali, MX	Manufacturing

Corporate Headquarters:

Duravent Group
 28 W. Adams, Suite 1810
 Detroit, MI 48226
 Tel: 800.835.4429
 Email: info@duraventgroup.com
www.duraventgroup.com



duravent[™]
GROUP

BUILD FOR THE FUTURE

www.duraventgroup.com



For warranty information:
Scan this QR code or visit
www.duraventgroup.com/warranties