



# SUPERPRO<sup>™</sup> *2100*

Chimney Catalog

FUEL TYPE: GAS | OIL | WOOD | COAL

CANADA ONLY



Typical Installation ..... 3

Technical Data Sheet ..... 4

Stainless Steel Chimney Lengths ..... 5

Stainless Steel Elbows and Tees..... 6-8

Supports ..... 8-9

Shields..... 10-11

Flashings and Storm Collars ..... 12-13

Premium Rain Caps ..... 14

Parts and Accessories ..... 14-15

Support Kits..... 16

# Typical Installation

## CEILING SUPPORT INSTALLATIONS

### One Story

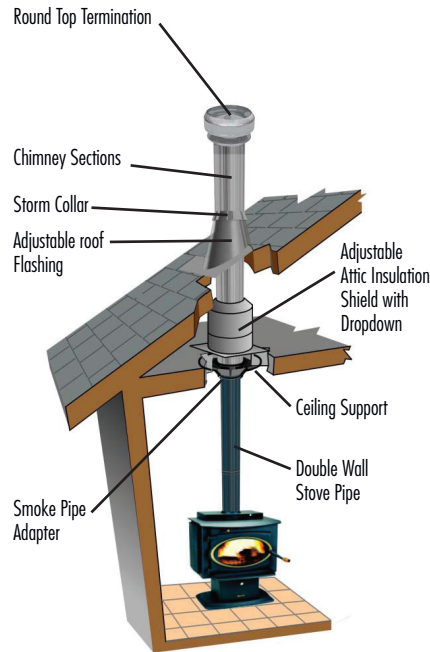

### Two Story

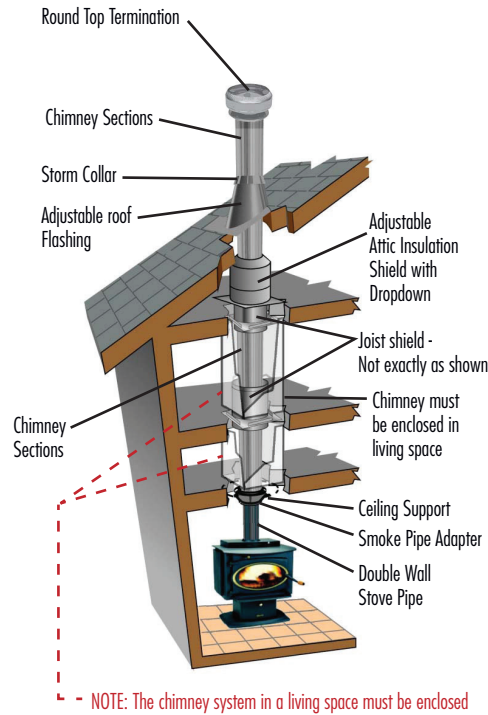

### Elbow Installation

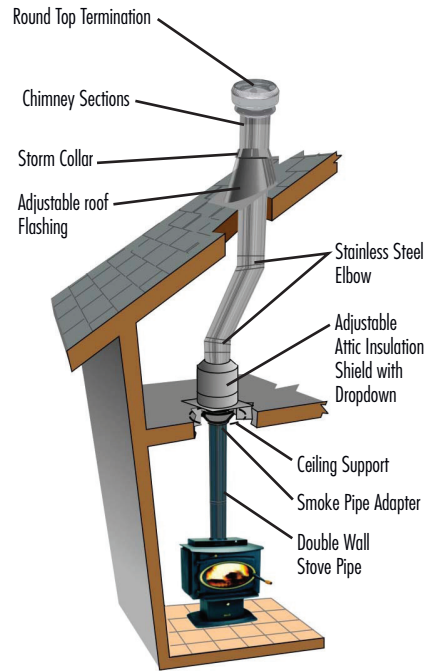

## CEILING SUPPORT INSTALLATIONS

### With Cathedral Ceiling Support Box

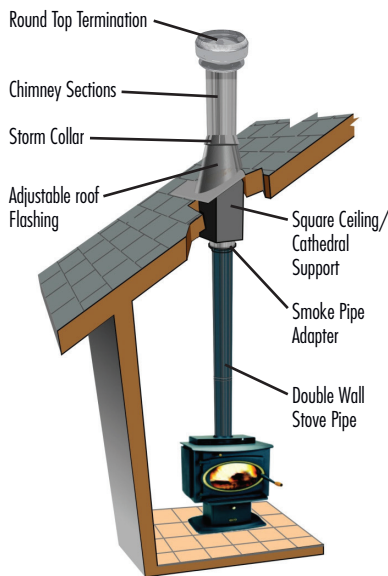

## WALL SUPPORT INSTALLATIONS

### One Story

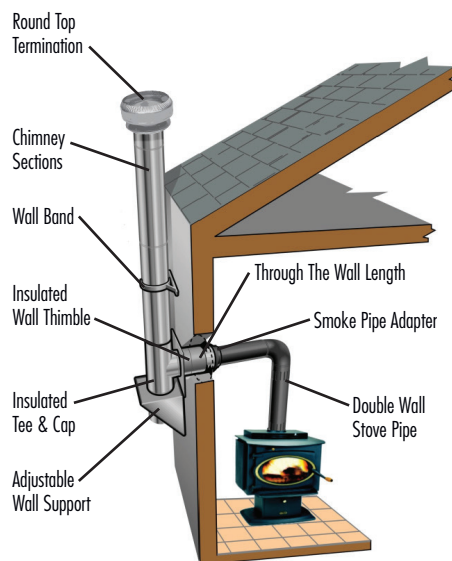

### Through a Soffit

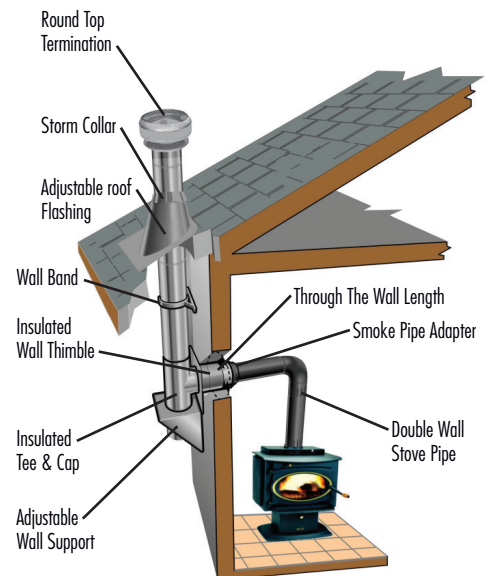

# SuperPro 2100 Premium Grade Stainless Steel Chimney

**FOR THE CHIMNEY PROFESSIONAL WHO DEMANDS THE BEST**

## Hi-Tech Chimney For Hi-Tech Wood Stoves

The SuperPro 2100 is designed for today's Wood Stoves which are engineered to produce low emissions, provide less heat up the chimney and more heat into the room. A high insulating value allows SuperPro to maintain a strong draft, even when faced with these low stack temperatures. This makes SuperPro 2100 the choice of professionals who are looking for a better quality, factory built chimney system.

## Test Standards

SuperPro 2100 has been tested and listed to ULC standard CAN/ULC-S629 requiring this system to withstand temperatures of up to 2100° F (1150°C) for three, thirty minute intervals. SuperPro 2100 chimney is also listed and tested to Type HT requirements of Underwriters Laboratories, Inc., Standard ANSI/UL 103 HT. SuperPro 2100 chimney conforms to the installation code for solid fuel burning appliances CSA B365. The minimum clearances shown are proven safe during the fire tests conducted with the component supports and spacers in actual contact with combustible framing. Proper installation must be followed with the instructions provided using each support assembly. Although primarily used in venting solid fuel applications, SuperPro 2100 is an all-fuel chimney also intended for venting gas or liquid fuel residential type appliances and building heating appliances.

## Premium Supports

Deluxe chimney support components will enhance any installation.

## Supports/Framing

All SuperPro 2100 Supports are designed to carry four times the combined weight of each system at maximum allowable height.

**Support and Framing Dimensions Table**

Support*	Ceiling Support	Wall Support	Cath. Ceiling Support	Roof Support
Diameter	40'	33'	18'	39'
Framing Dimensions				
6" Dia.	14-3/8" x 14-3/8"	14-3/8" x 14-3/8"	14" x 14"	14" x 14"
7" Dia.	14-3/8" x 14-3/8"	14-3/8" x 14-3/8"	15" x 15"	15" x 15"
8" Dia.	14-3/8" x 14-3/8"	14-3/8" x 14-3/8"	16" x 16"	16" x 16"

## Smart Choice Lifetime Warranty

The SuperPro 2100 Smart Choice Lifetime Warranty applies to all Chimney components (not just insulated lengths) making SuperPro 2100 chimney the smart choice, every time. (See written Warranty for details).

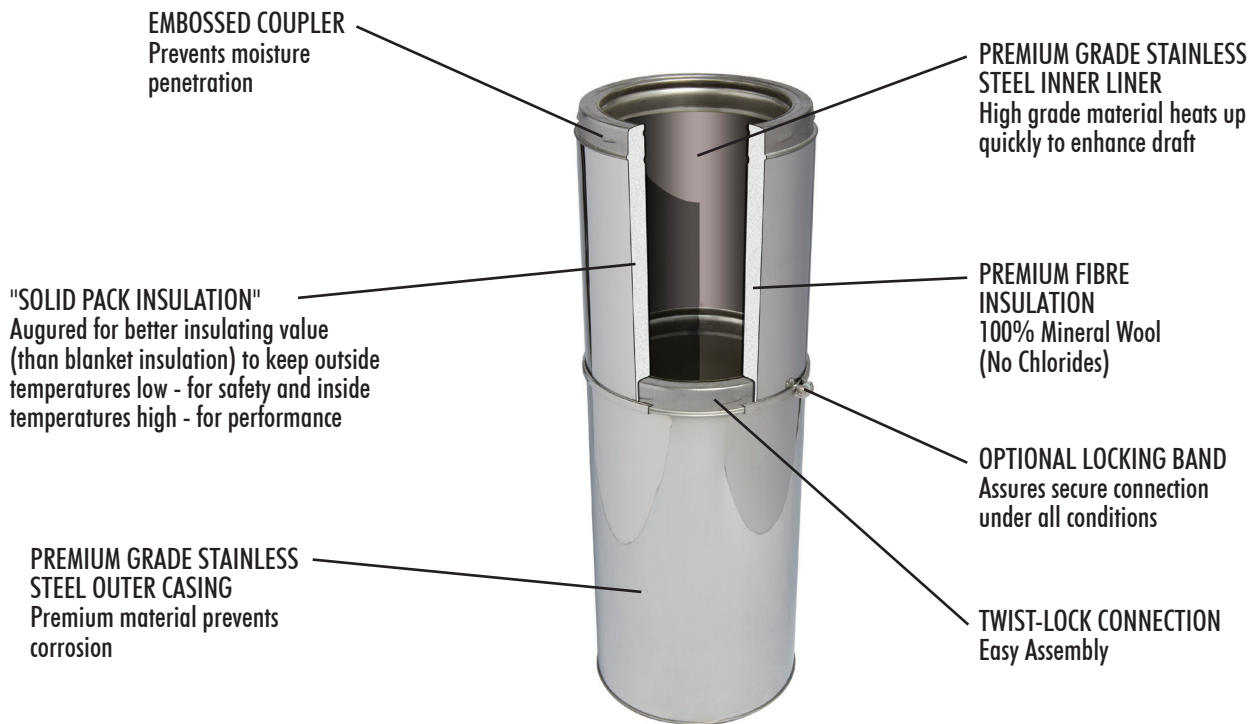

Not exactly as shown



### Smart Choice Lifetime Warranty

The SuperPro 2100 Smart Choice Lifetime Warranty applies to all Chimney components (not just insulated lengths) making SuperPro 2100 chimney the smart choice, every time. (See written Warranty for details)

## Stainless Steel Chimney Lengths

The chimney must extend at least three feet above the highest point where it passes through the roof surface and at least two feet higher than any part of the building within a horizontal distance of ten feet.

### HEIGHT REQUIREMENTS

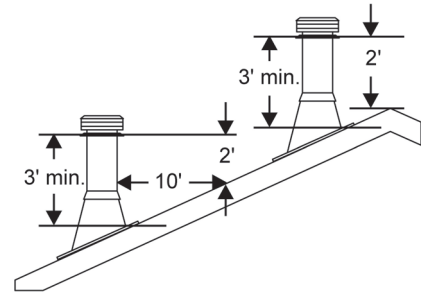

- Available in 36", 24", 18", 12" and 6" lengths
- SuperPro 2100 has a 2" wall thickness
- Secure twist-lock design couples chimney sections together with just a 1/8 turn
- Sectional overlap of 1-1/8"
- Chimneys are sized according to the inner diameter and are available in 6, 7, & 8 inch diameters
- Insulated chimney requires 2" clearance to combustible material

### CHIMNEY SECTIONS

Size	A	B	C	Product Code	Pack
6" x 36"	36"	6"	10"	ALT636	1
6" x 24"	24"	6"	10"	ALT624	1
6" x 18"	18"	6"	10"	ALT618	1
6" x 12"	12"	6"	10"	ALT612	1
6" x 6"	6"	6"	10"	ALT606	2
<b>7" Diameter</b>					
7" x 36"	36"	7"	11"	ALT736	1
7" x 24"	24"	7"	11"	ALT724	1
7" x 18"	18"	7"	11"	ALT718	1
7" x 12"	12"	7"	11"	ALT712	1
7" x 6"	6"	7"	11"	ALT706	2
<b>8" Diameter</b>					
8" x 36"	36"	8"	12"	JM8S36	1
8" x 24"	24"	8"	12"	JM8S24	1
8" x 18"	18"	8"	12"	JM8S18	1
8" x 12"	12"	8"	12"	JM8S12	1
8" x 6"	6"	8"	12"	JM8S6	2

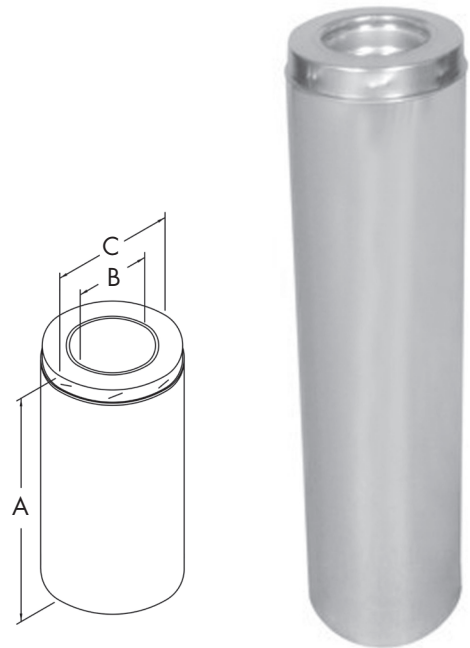

## LOCKING BANDS

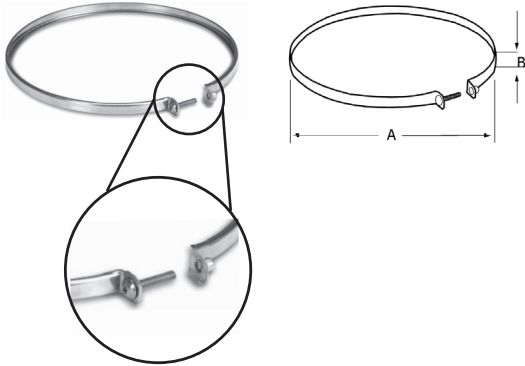

- Two flanges engage the curls in each end of the adjoining sections holding them securely together
- Supplied with Captured Nut & Bolt
- Locking Bands must be used:
  - on all sections that make up an offset
  - on tee branch to attach a chimney length
  - on any length suspended below the Cathedral or Roof Support
- While Locking Bands are not required on other chimney lengths, their use is recommended for added safety and stability. It also provides a more attractive appearance

Size	A	B		Product Code	Pack
6"	10"	7/16"		ALT6SLB	5
7"	11"	7/16"		ALT7SLB	5
8"	12"	7/16"		JM8SLB	5

## Stainless Steel Elbows and Tees

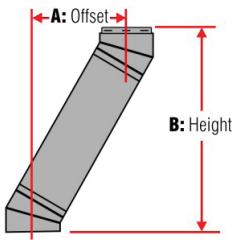

This chart has three columns for elbow angle required to achieve your desired offset.

The first column ("Offset") is the horizontal measurement, at the chimney center line, of the offset needed to get around an obstacle. The second column ("Height") is the height of the assembled offset elbow to the top of the return elbow. Column 3 shows the appropriate lengths required.

1. Determine the distance of the offset required.
2. On the chart, find the predetermined distance required for the 15° elbow kit under the corresponding chimney diameter. For greater offset, use the 30° or 45 degree elbow kit.
3. After finding the offset, follow across the chart to find the specified height and appropriate chimney lengths required under their corresponding diameters.

All measurements in inches. Offset tolerances ± one inch.

### 30° OFFSET CHART

Offset	Height			Lengths Required						
	6"	7"	8"	6"	7"	8"	12"	18"	24"	36"
3-9/16	3-3/4	3-7/8	14-3/16	15-1/2	15-3/8	-	-	-	-	-
5-7/8	6-1/4	6-3/8	18-5/16	19-1/2	19-3/4	1	-	-	-	-
8-7/8	9-1/4	9-3/8	23-9/16	24-3/4	25	-	1	-	-	-
11-15/16	12-5/16	12-7/8	28	29-13/16	30-1/16	-	-	1	-	-
14-15/16	15-5/16	15-7/16	34-1/16	35-3/8	35-1/4	-	-	-	1	-
17-5/16	17-5/8	17-9/16	38-5/16	39-3/16	39-5/8	1	1	1	-	-
20-7/8	21-1/4	21-7/16	44-9/16	45-5/8	46-1/16	-	-	-	-	1
23-5/16	23-11/16	23-7/8	48-15/16	49-3/4	50-3/16	1	-	1	1	-
26-5/16	26-11/16	26-7/8	54-1/8	54-15/16	55-9/16	-	1	-	-	1
29-5/16	29-11/16	29-9/16	59-5/16	60-1/8	60-3/4	-	-	1	-	1
32-5/16	32-9/16	32-5/8	64-3/8	64-5/8	65-1/4	-	-	-	1	1
34-5/8	35-1/8	35	68-1/2	68-3/4	69	1	1	1	-	1
37-13/16	38-1/8	38	73-13/16	74-1/16	74-5/16	-	1	-	1	1

### 45° OFFSET CHART

Offset	Height			Lengths Required						
	6"	7"	8"	6"	7"	8"	12"	18"	24"	36"
5-11/16	6	6-1/4	14-13/16	15-9/16	16-1/4	-	-	-	-	-
9-1/4	9-1/2	9-13/16	18-3/8	19-1/16	19-13/16	1	-	-	-	-
13-1/2	13-3/4	14-1/16	22-5/8	23-5/16	24	-	1	-	-	-
17-11/16	18	18-5/16	26-7/8	27-9/16	28-1/4	-	-	1	-	-
21-15/16	22-1/4	22-9/16	31-1/8	31-13/16	32-1/2	-	-	-	1	-
30-7/16	30-3/4	31	39-9/16	40-5/16	41	-	-	-	-	1
34	34-1/4	34-9/16	43-1/8	43-13/16	44-9/16	1	-	-	-	1
38-3/16	38-1/2	38-13/16	47-3/8	48-1/16	48-3/4	-	1	-	-	1
42-7/16	42-3/4	43-1/16	51-5/8	52-5/16	53	-	-	1	-	1
46-11/16	47	47-5/16	55-7/8	56-9/16	57-1/4	-	-	-	1	1
55-3/16	55-1/2	55-3/4	64-5/16	65-1/16	65-3/4	-	-	-	-	1



## Stainless Steel Elbows and Tees *continued*

- The Insulated Elbow is used when an offset is required
- Locking Bands must be used on all elbows
- Offsets cannot be more than 45° off the vertical
- A maximum of 6 feet is allowable between elbows
- Elbow is fully insulated and can be used at the same 2" clearance as chimney lengths
- Elbow support must be used with all offset installations
- Elbows do not have locking ridges and can be rotated to attain optimum positioning, and allow chimney to return to correct vertical alignment, prior to installing Locking Bands

**NOTE:** The Firestop Spacer (ALT\*FS) is a required component when using 45° Elbow Kit.

Size	A	B	C	Product Code	Pack
15° - 6"	3-7/16"	2-1/2"	2"	ALT6EL15K	2
15° - 7"	3-7/16"	2-9/16"	2-1/16"	ALT7EL15K	2
15° - 8"	3-7/16"	2-5/8"	2-1/8"	JM8SEK	2

Size	A	B	C	Product Code	Pack
30° - 6"	4-1/4"	3-3/4"	3-1/8"	ALT6EL30K	2
30° - 7"	4-1/4"	3-3/4"	3-1/2"	ALT7EL30K	2
30° - 8"	4-1/4"	3-3/4"	3"	JM8SE3K	2

Size	A	B	C	Product Code	Pack
45° - 6"	2-1/8"	3-1/8"	2-9/16"	ALT6E45K	2
45° - 7"	2-3/8"	3-3/8"	3"	ALT7E45K	2
45° - 8"	2-9/16"	3-3/4"	3-5/16"	JM8SE4K	2

- The insulated chimney tee is used for through-the-wall installation using a wall support
- A chimney length is attached to the tee branch using a Locking Band to pass safely through a wall

Size	A	B	C	D	E	Product Code	Pack
6"	10"	6"	13-1/4"	6-1/2"	6-1/2"	ALT6T	1
7"	11"	7"	14-1/4"	7"	7"	ALT7T	1
8"	12"	8"	15-1/4"	7-1/2"	7-1/2"	JM8SIT	1

- Twist locks into bottom of Adjustable Wall Support
- Removable to provide easy access for chimney maintenance or inspection
- Insulated to help maintain flue gas temperature

Size	A	B	C	Product Code	Pack
6"	10"	6"	3"	J62TPI	1
7"	11"	7"	3"	J72TPI	1
8"	12"	8"	3"	J82TPI	1

### INSULATED 15°, 30° AND 45° ELBOW KITS

**THIS KIT INCLUDES:**

- 2 Elbows
- 4 Locking Bands
- 1 Elbow Support

**NOTE:** A Corner Shield Plate is supplied with the 45° Elbow Kit.



#### 15° ELBOW

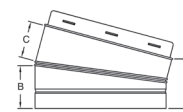

#### 30° ELBOW

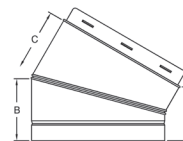

#### 45° ELBOW

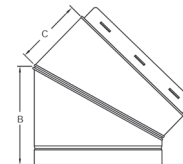

### INSULATED TEE WITH PLUG

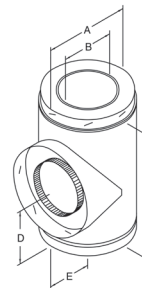

### INSULATED TEE PLUG

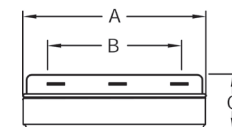

**NON-TWIST INSULATED TEE CAP**

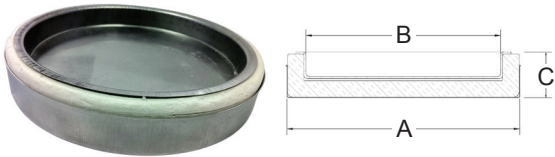

- Replacement Non-Twist Lock Insulated Tee Cap used with the WS Wall Support.
- Removable to provide easy access for chimney inspection and maintenance.
- Insulated to help maintain flue gas temperature.

Size	A	B	C	Product Code	Pack
6"	7-1/16"	6-1/16"	1-17/64"	SPR6NTITC	1
7"	8-1/16"	7-1/16"	1-17/64"	SPR7NTITC	1
8"	9-1/16"	8-1/16"	1-17/64"	SPR8NTITC	1

**Supports**

**ADJUSTABLE WALL SUPPORT**

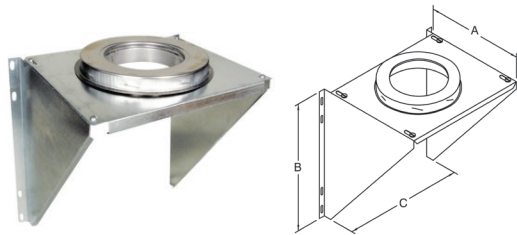

- Used to support the chimney on a wall installation
- Supports up to 33 feet of chimney. If chimney extends over 33 feet, Adjustable Intermediate Wall Support must also be used
- Includes wall support top plate with female coupler attached, male coupler, side brackets and hardware

Size	A	B	C	Product Code	Pack
6"	13"	17-1/8"	16"	JM6AWS	1
7"	14"	17-1/8"	16"	JM7AWS	1
8"	15"	17-1/8"	16"	JM8AWS	1

**ADJUSTABLE INTERMEDIATE WALL SUPPORT**

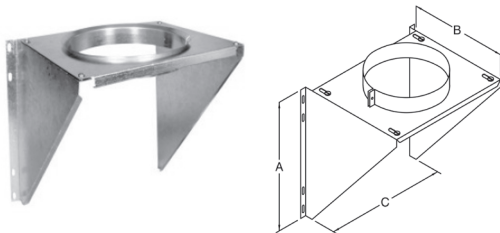

- Used as supplementary support when chimney system height exceeds maximum height allowed by wall support
- Supports an additional 33 feet of chimney
- Includes Top Plate, Support Band, Side Brackets and Hardware

Size	A	B	C	Product Code	Pack
6"	17-1/8"	13"	16"	JM6AIWS	1
7"	17-1/8"	14"	16"	JM7AIWS	1
8"	17-1/8"	15"	16"	JM8AIWS	1

**ADJUSTABLE WALL SUPPORT WITH INSULATED TEE CAP**

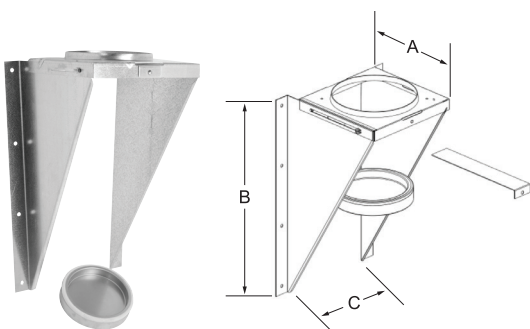

- Used to support chimney on a through-the-wall installation
- Will support between 16 feet and 34 feet of chimney height based on size & orientation from wall
- Adjustment of 2" to 6" from a vertical wall
- Includes wall support top plate, side brackets, hardware, non-twist lock insulated tee cap, and L-bracket to contain tee cap

Size	A	B	C	Product Code	Pack
6"	11-1/4"	21-7/8"	11-1/2"	JM6WS	1
7"	12-1/4"	23-9/16"	12-1/2"	JM7WS	1
8"	13-1/4"	25-1/4"	13-1/2"	JM8WS	1



## Supports continued

- Used in pitched ceiling support installations
- Supports up to 18 feet of chimney
- Matte black finish
- Includes 4 Trim Angles for an attractive interior finish

Size	A	B	C	Product Code	Pack
6"	10-3/16"	14"	17"	ALT6CB	1
7"	11-3/16"	15"	17"	ALT7CB	1
8"	12-3/16"	16"	17"	JM8CCSB	1

- The Roof Support may be used on a floor, ceiling or roof and adjusts to any roof pitch
- It may be used above an offset to support the offset or as a supplementary support when the chimney height exceeds that of the primary support
- The Roof Support will support a total height of 39 feet of chimney

Size	A	B	Product Code	Pack
6"	10"	5"	JM6RS	1
7"	11"	5"	JM7RS	1
8"	12"	5"	JM8RS	1

- For use in ceiling support installations
- Supports up to 40 feet of chimney
- Matte black finish gives a premium finished appearance

Size	A	B	C	Product Code	Pack
6"	19-7/8"	14-3/8"	10"	ALT6CS-1	1
7"	19-7/8"	14-3/8"	11"	ALT7CS-1	1
8"	19-7/8"	14-3/8"	12"	JM8DCS-1	1

- The Adaptor Plate (AP) is intended for use with a masonry fireplace with chimney models JM or ALT
- May also be used with specific factory-built fireplaces listed to UL 127 or CAN/ULC-S610

Size	A	B	Product Code	Pack
6"	6"	11-5/8"	JM6AP	1
7"	7"	13"	JM7AP	1
8"	8"	13"	JM8AP	1

### CATHEDRAL CEILING SUPPORT BOX

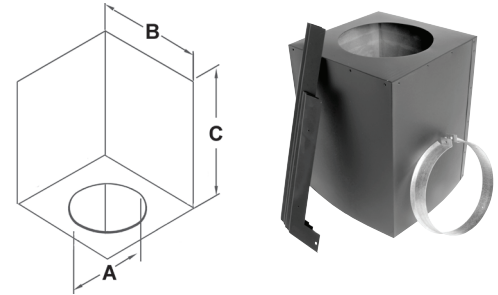

Add JUSI (pg. 15) to the Cathedral Ceiling Support for increased performance and safety.

### ROOF SUPPORT

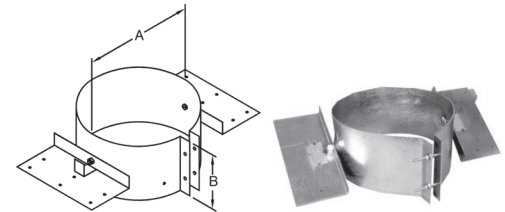

### DECORATOR CEILING SUPPORT

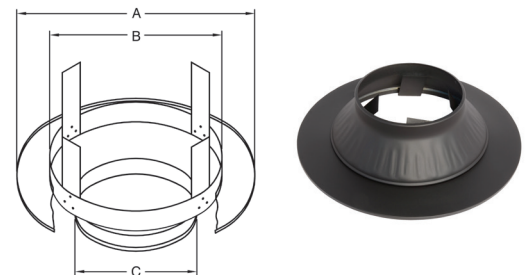

### ADAPTOR PLATE

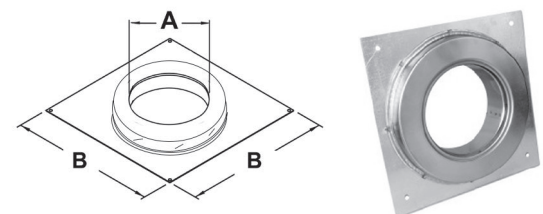

## Shields

### ADJUSTABLE ATTIC INSULATION SHIELD WITH DROP DOWN

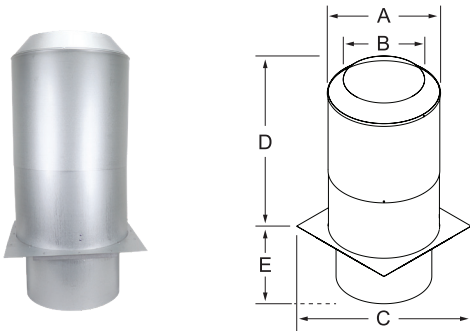

Add JUSI (pg. 15) to the Attic Insulation Shield for increased performance and safety.

- The Adjustable Attic Insulation Shield with Dropdown must be installed where the chimney enters the attic space in any installation.
- Designed to keep insulation away from the chimney and to maintain the mandatory 2" clearance to combustibles.
- Adjustable from 12" to 22".
- Drop down shield protects joist area.

Size	A	B	C	D	E	Product Code	Pack
6"	14"	10-5/16"	16"	12" to 22"	8-1/2"	JM6AAIS	1
7"	15"	11-5/16"	17"	12" to 22"	8-1/2"	JM7AAIS	1
8"	16"	12-5/16"	18"	12" to 22"	8-1/2"	JM8AAIS	1

### RAFTER RADIATION SHIELD

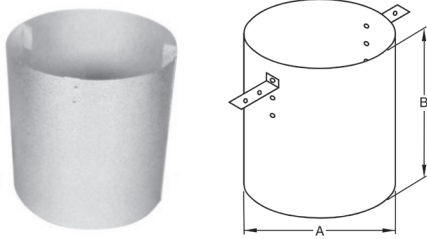

The RRS must be installed where the chimney is enclosed immediately below the roof line.

Size	A	B	Product Code	Pack
6"	12"	12"	JM6RRS	1
7"	13"	12"	JM7RRS	1
8"	14"	12"	JM8RRS	1

### BLACK WALL THIMBLE

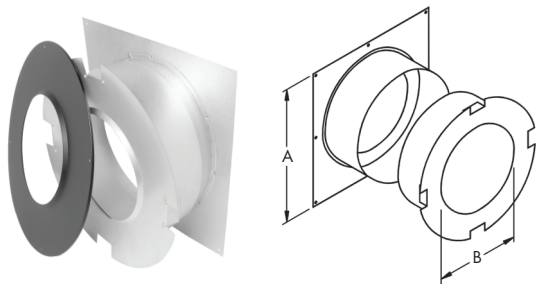

Add JUSI (pg. 15) to the Wall Thimble for increased performance and safety.

- Used in a wall support installation
- Radiation shield is included with spacers which maintain the mandatory 2" clearance to combustibles
- Attractive matte black finishing trim is included
- Extends to fit 4-1/2" to 8-3/4" wall thickness

Size	A	B	Product Code	Pack
6"	17"	10-1/8"	ALT6AT	1
7"	17"	11-1/8"	ALT7AT	1
8"	17"	12-1/8"	JM8WT	1

## Shields continued

- Required at all ceiling levels when 45° Elbows are used
- Serves as a firestop, ensures proper spacing is maintained and provides joist protection
- Integrated spacers to maintain the mandatory 2" clearance to combustibles
- Can also be used as an alternate with 15° or 30° Elbows when using an Attic Insulation Shield per instructions
- The Firestop Spacer must be installed where the chimney passes through the dwelling from one living space to another living space. It is also required when the chimney is enclosed in the attic.

Size	A	B	C	Product Code	Pack
6"	10-5/16"	6"	13-3/8"	JM6FS	1
7"	11-5/16"	8"	14-3/8"	JM7FS	1
8"	12-5/16"	10"	15-3/8"	JM8FS	1

### FIRESTOP SPACER - RADIATION JOIST SHIELD

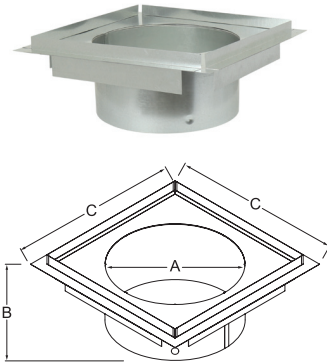

## Flashings and Storm Collars

### ROOF FLASHING SELECTION CHART

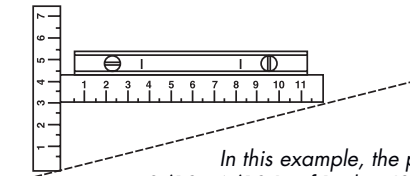

In this example, the pitch is 3/12.  
 0/12 - 6/12 Roof Pitch = JSC 6 or 7 AAF  
 6/12 - 12/12 Roof Pitch = JSC 6 or 7 AF2

To determine what Roof Flashing you'll require, you must work out the pitch of your roof. To determine the pitch, you'll need two rulers and a level. Measure the number of inches from the end of the level down to the roof.

### ADJUSTABLE FLASHING ASSEMBLY- FLAT TO 6/12

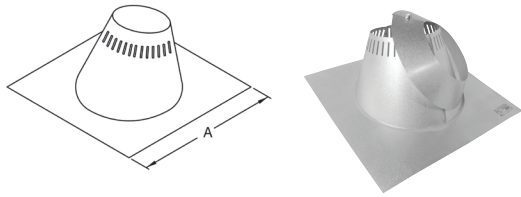

- Used where the chimney passes through a roof with a pitch of 1/12 to 6/12
- Comes complete with Storm Collar
- All seams are sealed with Silicone Sealant
- Galvalume construction

Size	A	Product Code	Pack
6"	27-1/2" x 27-1/2"	JM6AAF	1
7"	27-1/2" x 27-1/2"	JM7AAF	1
8"	27-1/2" x 27-1/2"	JM8AAF	1
<b>3 Pack</b>			
6"	27-1/2" x 27-1/2"	JM6AAF-3	3
7"	27-1/2" x 27-1/2"	JM7AAF-3	3
8"	27-1/2" x 27-1/2"	JM8AAF-3	3

### ADJUSTABLE FLASHING ASSEMBLY- 6/12 TO 12/12

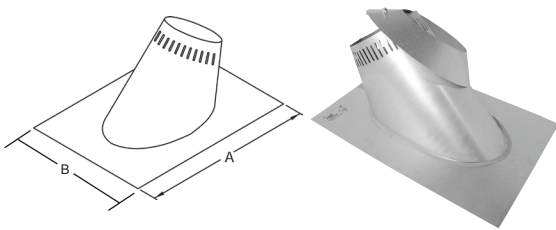

- Used where the chimney passes through a roof with a pitch of 6/12 to 12/12
- Comes complete with Storm Collar
- All seams are sealed with Silicone Sealant
- Galvalume construction

Size	A	B	Product Code	Pack
6"	30"	21-1/2"	JM6AF2	1
7"	30"	21-1/2"	JM7AF2	1
8"	30"	21-1/2"	JM8AF2	1
<b>3 Pack</b>				
6"	30"	21-1/2"	JM6AF2-3	3
7"	30"	21-1/2"	JM7AF2-3	3
8"	30"	21-1/2"	JM8AF2-3	3

### TALL CONE FLASHING

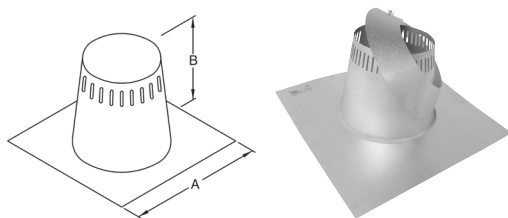

- Used on flat roof surfaces
- Comes complete with Storm Collar
- All seams are sealed with Silicone Sealant

Size	A	B	Product Code	Pack
6"	27"	12"	JM6ATC	1
7"	27"	12"	JM7ATC	1
8"	27"	12"	JM8ATC	1

## Flashings and Storm Collars *continued*

- Required where the chimney passes through a peaked roof with a pitch of 3/12 to 6/12
- Comes complete with Storm Collar
- Seams are sealed with Silicone Sealant
- Galvalume construction

Size	A	B	Product Code	Pack
6"	24"	10"	JM6P1	1
7"	24"	10"	JM7P1	1
8"	24"	10"	JM8P1	1

- Required where the chimney passes through a peaked roof with a pitch of 6/12 to 9/12
- Comes complete with Storm Collar
- Seams are sealed with Silicone Sealant
- Galvalume construction

Size	A	B	Product Code	Pack
6"	21-1/2"	11-1/2"	JM6P2	1
7"	21-1/2"	12"	JM7P2	1
8"	21-1/2"	11-1/2"	JM8P2	1

- This kit fits 6", 7" and 8" Chimneys
- Required where the chimney passes through a corrugated roof
- Rubber Boot Flashing fits roof pitches up to 10/12 for 6", 9/12 for 7" and 8/12 for 8"

Size	Product Code	Pack
ALL	JURBFK2	1

Used in conjunction with Roof Flashing to keep precipitation out.

Size	A	B	Product Code	Pack
6"	10"	5-1/2"	JM6ASC-1	1
7"	11"	5-1/2"	JM7ASC-1	1
8"	12"	5-1/2"	JM8ASC-1	1

- Used to seal Storm Collar to chimney length above cone of flashing
- 3 ounce tubes

Size	Product Code	Pack
1 tube	JRTV	1

### PEAK FLASHING - 3/12 TO 6/12

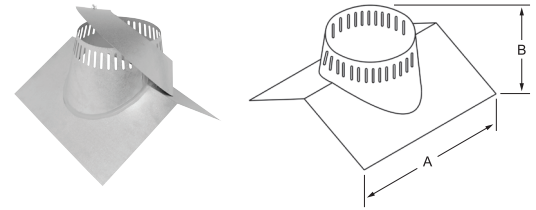

### PEAK FLASHING - 6/12 TO 9/12

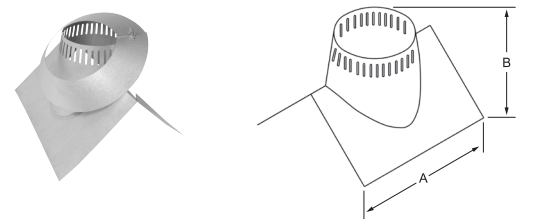

### RUBBER BOOT FLASHING KIT



#### THIS KIT INCLUDES:

- Special Storm Collar
- Rubber Boot.
- Spacer Kit.
- Special Boot Mounting Screws

### ALUMINUM STORM COLLAR

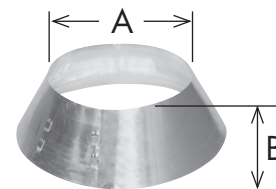

### SILICONE SEALANT FOR STORM COLLAR



## Premium Rain Caps

### PREMIUM RAIN CAP

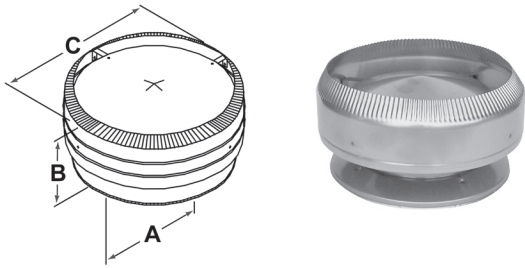

- Advanced design, premium quality 304 stainless steel
- Provides protection against precipitation and creates a venturi effect to enhance draught
- Twist-lock connection for secure installation

Size	A	B	C	Product Code	Pack
6"	10"	7-1/2"	13-1/4"	ALT6PRC	1
7"	11"	7-1/2"	14-1/4"	ALT7PRC	1
8"	12"	7-1/2"	17-1/4"	JM8DRC	1

### SPARK ARRESTOR

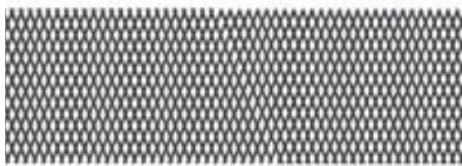

Stainless steel mesh wire fits inside Premium Rain Cap.

Size	Dimensions	Product Code	Pack
6"	4-1/2" x 26"	JSC6SPAR	10
7"	4-1/2" x 29"	JSC7SPAR	10
8"	4-1/2" x 32"	JSC8SPAR	10

### DIKAPT CHIMNEY CAP

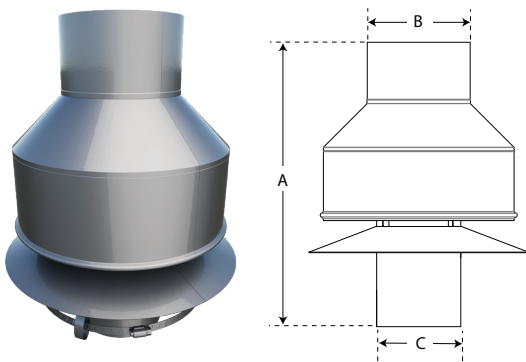

- Designed to address chimneys with downdraft issues.
- Diverts wind and rain to ensure flue gases are directed outward efficiently & effectively.
- Constructed of 300 Series Stainless Steel for strength & durability.
- Available in 5", 6", 7", 8" & 10" Diameters
- Listed & approved to UL 103HT

Size	A	B	C	Product No.	Part No.	Pack
5"	17-1/4"	6"	4-3/4"	195802	5DK	1
6"	19-1/4"	7"	5-3/4"	196802	6DK	1
7"	19-1/4"	8"	6-3/4"	197802	7DK	1
8"	19-1/4"	9"	7-3/4"	198802	8DK	1
10"	19-1/4"	11"	9-3/4"	1910802	10DK	1



## Parts and Accessories

- Stainless steel construction
- Provides lateral support for the chimney when installed adjacent to a wall
- Maintains the mandatory 2" clearance to combustibles
- Install midway on the length above the Tee, then every 8 feet thereafter

Size	A	B	Product Code	Pack
6"	10"	17"	JM6WB	1
7"	11"	17"	JM7WB	1
8"	12"	17"	JM8WB	1

### WALL BAND

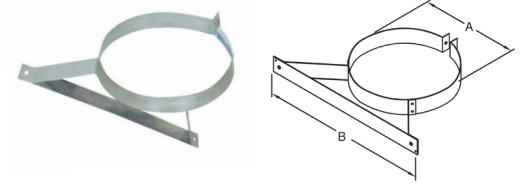

- Quick and easy transition from black stove pipe or Double Wall Black Stove Pipe to factory-built chimney
- Twist-lock for easy connection
- Stainless Steel

Size	A	B	C	Product Code	Pack
6"	10"	6"	5-5/8"	JM6ASE	1
7"	11"	7"	5-5/8"	JM7ASE	1
8"	12"	8"	5-5/8"	JM8ASE	1

### BLACK STOVE PIPE ADAPTER

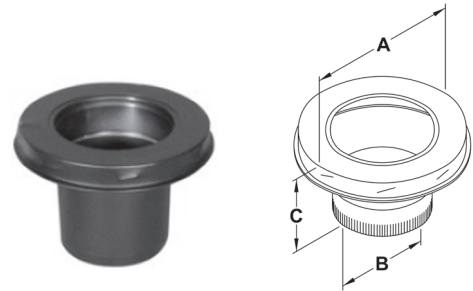

**FINISHING PLATE**

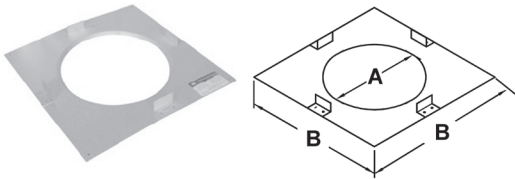

- Used where the chimney passes through a soffit to provide a finished appearance
- Maintains the mandatory 2" clearance to combustibles

Size	A	B	Product Code	Pack
6"	10-3/16"	16"	JM6FP	1
7"	11-3/16"	17"	JM7FP	1
8"	12-3/16"	18"	JM8FP	1

**HD UNIVERSAL ROOF BRACE KIT**



- Designed to provide extra stability for chimney system above roof line
- Required when the chimney extends 5 feet or more above the roof. Use one kit every 5 feet
- Telescoping legs can adjust from 5' to 9'
- Support band adjusts to fit 6", 7", and 8" chimney

Size	Product Code	Pack
6" to 8"	0843900	1

**JUSI-UNIVERSAL SHIELDING INSULATION**

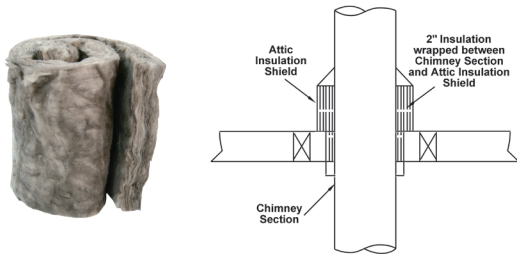

- Insulation for use with:
  - Attic Insulation Shield (JM\*AAIS)
  - Wall Thimble (ALT\*AT and JM8WT)
  - Cathedral Ceiling Support (ALT\*CB and JM8CCSB)
- Reduces cold air infiltration into the dwelling
- Provides additional protection against heat from the chimney

Size	Product Code	Pack
Universal	JUSI	1

**MASONRY ADAPTER PLATE**

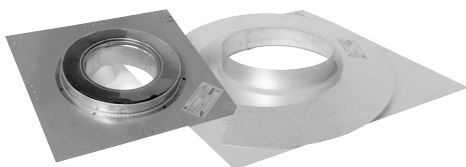

- Kit includes Anchor Plate, Masonry Flashing and Storm Collar
- Used to extend the height of a masonry chimney using SuperPro 2100 chimney
- Available in 6", 7", and 8" diameters

Size	Product Code	Pack
6"	JM6MAK	1
7"	JM7MAK	1
8"	JM8MAK	1

## Support Kits

SuperPro 2100 has put together 3 chimney kits to get your project done . . .

We often hear “Kits don’t work” from our Hearth customers!

. . . Here is the strategy behind our SuperPro 2100 Kits - and why they make sense for you.

- A Kit is available for each of the 3 main methods of supporting a chimney system.
- Each Kit **ONLY** includes the parts that are used in the majority of every installation.
- Kits do **NOT** include any parts that may vary in different applications, such as Roof Flashings, Chimney Lengths, etc.

Simply decide which of these scenarios fits your need, then pick up your chimney lengths, roof flashing and elbows (if required).

When your chimney goes up through a flat ceiling, attic space, then thru the roof, you may choose the MODEL SuperPro 2100 DECORATOR CEILING SUPPORT INSTALLATION KIT - ALT\*DCSP-N

- Premium Rain Cap
- Adjustable Attic Insulation Shield with Dropdown
- Decorator Ceiling Support
- Stove Pipe Adaptor

**NOTE:** In a two story application, purchase the Ceiling Support Installation Kit (DCSP-N) and install a Firestop Spacer at the ceiling level to provide proper fire stopping.

. . . Now you just need your roof flashing and chimney lengths.

### CEILING SUPPORT KIT

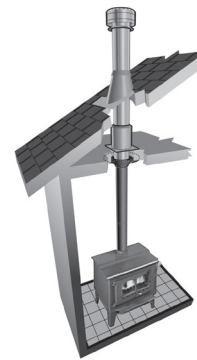

Size	Product Code
6"	ALT6DCSP-N
7"	ALT7DCSP-N

When your chimney goes out a cathedral or open beam ceiling, you may choose the MODEL SuperPro 2100 CATHEDRAL CEILING SUPPORT INSTALLATION KIT - ALT\*CCSK

- Premium Rain Cap
- Cathedral Ceiling Support
- Draw Band
- Trim Kit
- Stove Pipe Adaptor

...Now you just need your roof flashing and chimney lengths.

### CATHEDRAL CEILING SUPPORT KIT



Size	Product Code
6"	ALT6CCSK
7"	ALT7CCSK

When your chimney goes out a wall and then runs straight up, you’ll need the MODEL SuperPro 2100 WALL SUPPORT INSTALLATION KIT - ALT\*WSP

- Premium Rain Cap
- Wall Bands (2)
- Stove Pipe Adaptor
- Wall Thimble
- Stainless Steel Tee with Plug
- Adjustable Wall Support

...Now you just need:

- Vertical Chimney lengths
- Through the wall length (must extend at least 3" into the room)
- 12" chimney length or insulated tee plug (installed below the wall support)

### WALL SUPPORT KIT

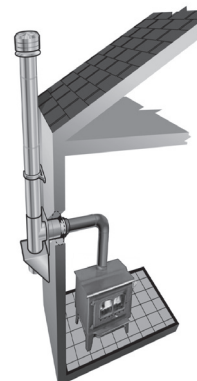

Size	Product Code
6"	ALT6WSP
7"	ALT7WSP





BUILD FOR THE FUTURE

Customer Service and Support:

Airmate (USA).....	800.992.8368
Airmate (CAN) .....	888.735.5475
Ameriflow .....	800.252.8467
Amerivent (Retail).....	800.252.8467
Amerivent (Hearth & Wholesale) ....	800.423.4270
Amerivent (Support).....	800.748.0392
AMPCO (USA) .....	800.669.3269
AMPCO (CAN).....	888.735.5475
Duravent .....	800.835.4429
Hart & Cooley.....	800.433.6341
Hart & Cooley (Support) .....	800.748.0392
Heatfab (USA).....	800.772.0739
Heatfab (CAN) .....	800.848.2149
Lima.....	800.423.4270
Milcor .....	800.774.5240
Portals Plus.....	800.774.5240
RPS.....	800.624.8642
Security Chimney (USA).....	800.361.4909
Security Chimney (CAN) .....	800.667.3387
Selkirk (USA) Residential .....	800.992.8368
Selkirk (USA) Commercial.....	800.848.2149
Selkirk (USA) Support.....	800.748.0392
Selkirk (CAN) .....	888.735.5475

Manufacturing & Distribution Centers:

CANADA	
Nobel, ON	Manufacturing
Laval, QC	Manufacturing
Prescott, ON	Distribution
USA	
Grand Rapids, MI	Center of Excellence
Dallas, TX	Distribution
Englewood, OH	Distribution
Huntsville, AL	Manufacturing & Distribution
Mira Loma, CA	Distribution
Nampa, ID	Manufacturing & Distribution
Turner Falls, MA	Manufacturing & Distribution
Vacaville, CA	Manufacturing
MEXICO	
Ojinaga, MX	Manufacturing
Mexicali, MX	Manufacturing

Corporate Headquarters:

Duravent Group  
 28 W. Adams, Suite 1810  
 Detroit, MI 48226  
 Tel: 800.835.4429  
 Email: [info@duraventgroup.com](mailto:info@duraventgroup.com)  
[www.duraventgroup.com](http://www.duraventgroup.com)



**duravent**<sup>™</sup>  
GROUP

BUILD FOR THE FUTURE

[www.duraventgroup.com](http://www.duraventgroup.com)



For warranty information:  
Scan this QR code or visit  
[www.duraventgroup.com/warranties](http://www.duraventgroup.com/warranties)