

**FUEL TYPE:**

Gas | Oil



## TABLE OF CONTENTS

---

Typical Installations .....	3
Technical Data Sheet .....	4
Support Kits.....	5
Stainless Steel Chimney Lengths .....	6
Stainless Steel Elbows.....	7-8
Tee Components .....	9
Supports .....	9-11
Shields.....	11-12
Flashings and Storm Collars .....	12-14
Rain Caps .....	14
Parts and Accessories .....	15-16
Fireplace Parts.....	17

# Typical Installation

## CEILING SUPPORT INSTALLATIONS

### One Story

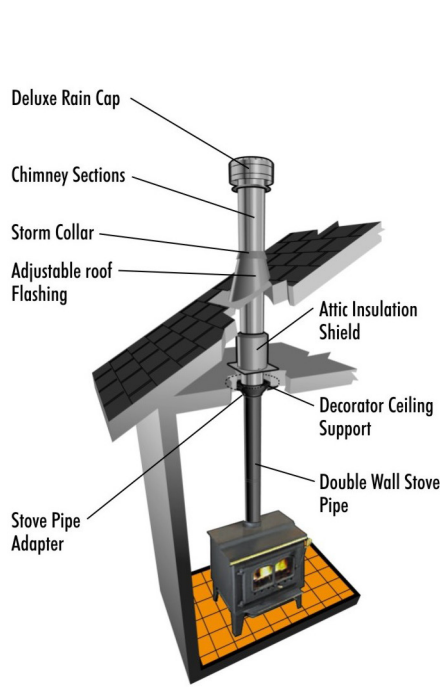

### Two Story

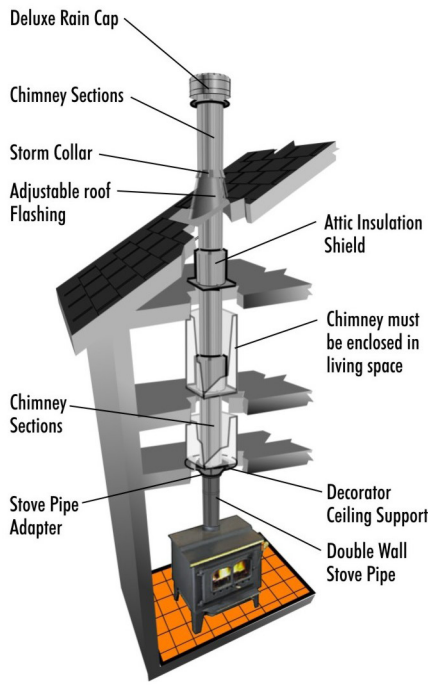

### Elbow Installation

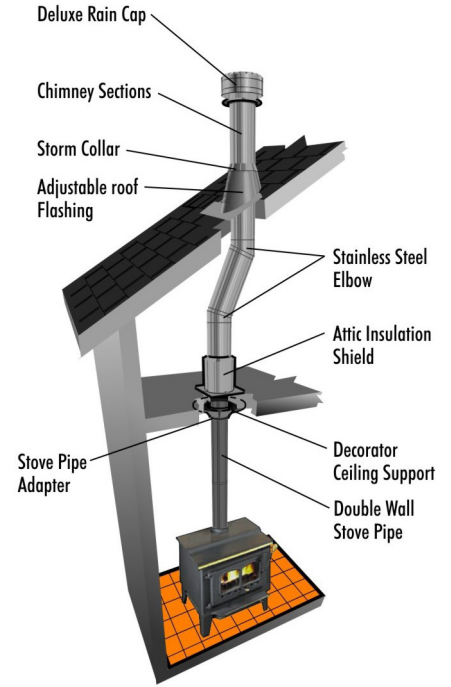

## CEILING SUPPORT INSTALLATIONS

### With Cathedral Ceiling Support Box

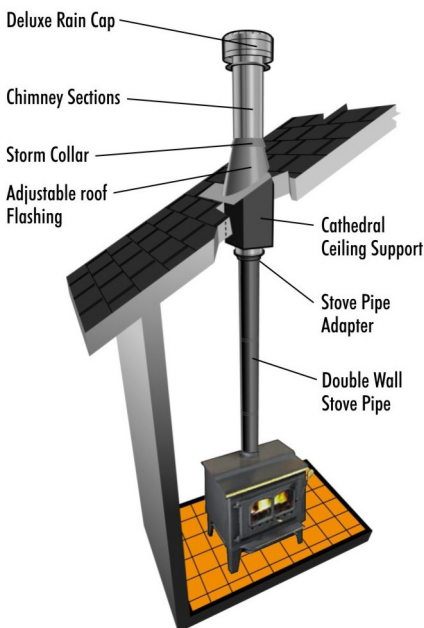

## WALL SUPPORT INSTALLATIONS

### One Story

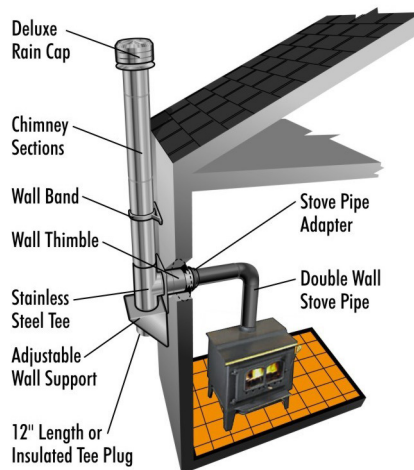

### Through a Soffit

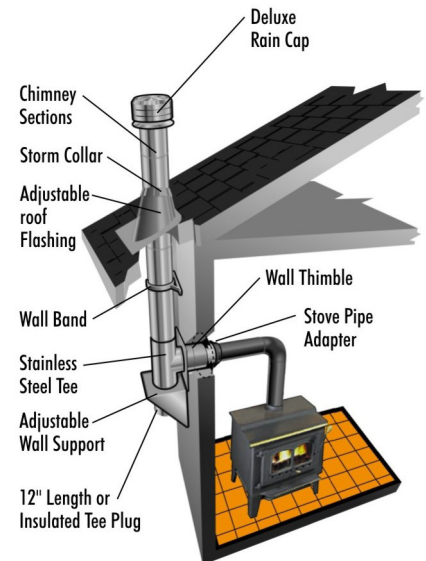

For Wood Fireplace Installations, consult the Installation Instructions supplied with each Fireplace unit.



# SuperVent Model JSC Technical Data Sheet

## CERTIFICATION & APPLICATIONS

SuperVent Model JSC is Safety Tested and Listed to applicable UL/ULC Standards. These include:

### USA: UL 103-HT

Safety Standards for chimneys serving solid fuel and liquid fuel appliances. This chimney system has been designed for use on wood stoves, fireplaces and residential furnaces in the U. S. market.

Allowable Flue Gas Temperatures are:

Maximum Continuous	1000° F / 540° C
Brief Forced Firing	1400° F / 760° C (60 min.)
Creosote Burn Out	2100° F / 1150° C (3 x 10 min.)

### Canada: ULC S-604

Safety Standard for chimneys serving liquid/gas fuel appliances  
This chimney system may be used on appliances that burn Oil or Gas.  
SuperVent Model JSC may also be used with specific listed factory-built fireplaces listed to UL 127 or ULC-S610.

## CLEARANCE TO COMBUSTIBLE MATERIALS:

A 2" clearance to combustible materials must be maintained at all times, except in areas protected by factory supplied supports certified for reduced clearance.

## CONSTRUCTION

Inner Liner (Flue):	Upgraded Stainless Steel 0.016" thickness
Outer Casing:	Upgraded Stainless Steel 0.015" thickness.

**Note:** All SuperVent Twist-Lock Couplers are embossed (not lanced). Welded seams are weather-proofed to prevent moisture from entering the chimney.

Insulation: The 1" space between the inner/outer walls is Solid Packed with Mineral Wool Fibre insulation to provide superior insulating qualities, in a "slim-line" design. Solid Pack design performs favorably to Blanket type and Air-Cooled chimney designs.

## SUPPORTS/FRAMING

All SuperVent Supports are designed to carry four times the combined weight of each system at maximum allowable height.

**Support and Framing Dimensions Table**

Support*	Ceiling Support	Wall Support	Cath. Ceiling Support	Roof Support
Diameter	50'	38'	38'	50'
<b>Framing Dimensions</b>				
5" Dia.	11-3/8" x 11-3/8"	14-3/8" x 14-3/8"	11" x 11"	N/A
6" Dia.	12-3/8" x 12-3/8"	14-3/8" x 14-3/8"	12" x 12"	N/A
7" Dia.	13-3/8" x 13-3/8"	14-3/8" x 14-3/8"	13" x 13"	N/A
8" Dia.	14-3/8" x 14-3/8"	14-3/8" x 14-3/8"	14" x 14"	N/A

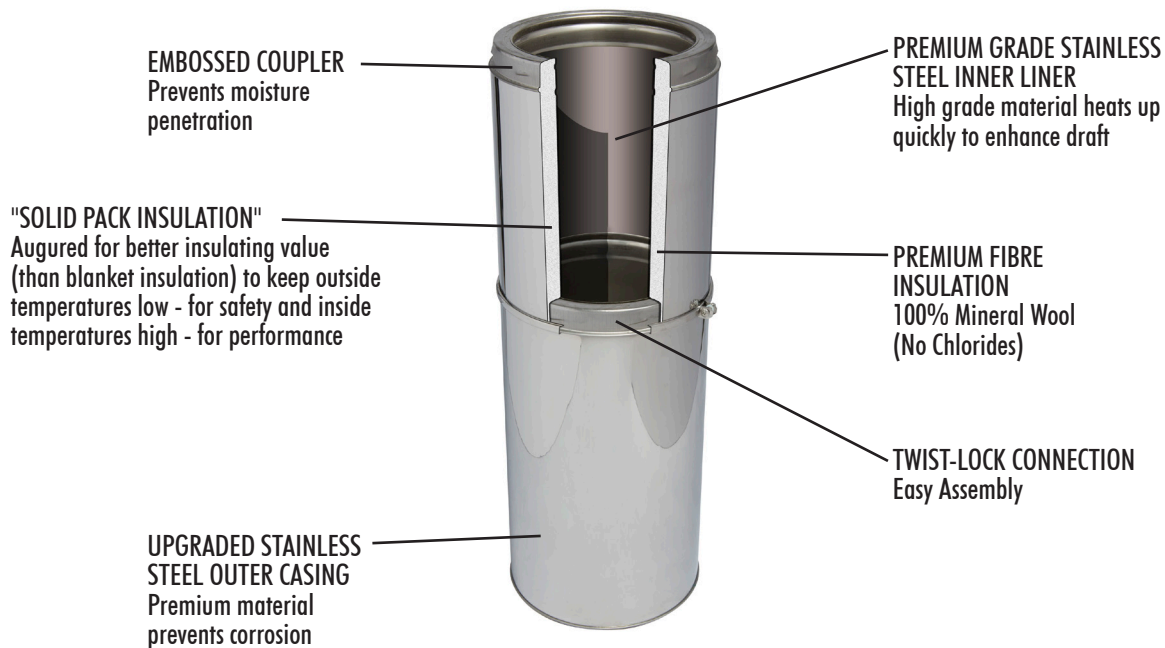

### The Best Warranty in the Industry

Selkirk features an advanced engineering design and premium quality material which allow us to offer a Lifetime Warranty on all component parts. See written warranty for details.

## Support Kits

**SuperVent has put together 3 chimney kits to get your project done . . .**

Model JSC has taken the guess work out of chimney installation by putting the most common parts for each installation all in one box. These 3 kits depict the most common installations. Simply decide which of these scenarios fits your need, then pick up your chimney lengths, roof flashing and elbows (if required).

### “My chimney runs straight up through the flat ceiling.”

When your chimney goes up through a flat ceiling, attic then through the roof, you may choose the MODEL JSC DECORATOR CEILING SUPPORT INSTALLATION KIT - JSC\*DCSK

- Deluxe Rain Cap
- Attic Insulation Shield
- Decorator Ceiling Support
- Stove Pipe Adaptor

NOTE: For a two story application, purchase the Ceiling Support Kit and install an additional Firestop Radiation Shield to provide proper fire stopping.

...Now you just need your roof flashing and chimney lengths.

### “My chimney runs out the roof through a cathedral ceiling.”

When your chimney goes out a cathedral or open beam ceiling, you may choose the MODEL JSC CATHEDRAL CEILING SUPPORT INSTALLATION KIT - JSC\*CCSK

- Deluxe Rain Cap
- Cathedral Ceiling Support
- Draw Band
- Trim Kit
- Stove Pipe Adaptor

...Now you just need your roof flashing and chimney lengths

### “My chimney runs out the wall and then straight up.”

When your chimney goes out a wall and then runs straight up, you'll need the MODEL JSC WALL SUPPORT INSTALLATION KIT - JSC\*WSK.

- Deluxe Rain Cap
- Wall Bands (2)
- Stove Pipe Adaptor
- Wall Thimble
- Stainless Steel Tee with Plug
- Adjustable Wall Support (AWS)

...Now you just need:

- Vertical Chimney lengths
- Through the wall length (must extend at least 3" into the room)
- 12" chimney length or insulated tee plug (installed below the Wall Support)

### CEILING SUPPORT KIT

Size	Product Code
5"	JSC5DCSK
6"	JSC6DCSK
7"	JSC7DCSK
8"	JSC8DCSK

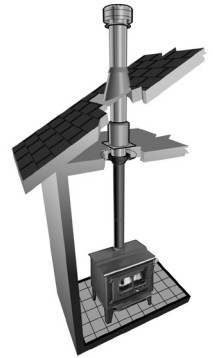

### CATHEDRAL CEILING SUPPORT KIT

Size	Product Code
6"	JSC6CCSK
7"	JSC7CCSK
8"	JSC8CCSK



### WALL SUPPORT KIT

Size	Product Code
5"	JSC5WSK
6"	JSC6WSK
7"	JSC7WSK
8"	JSC8WSK

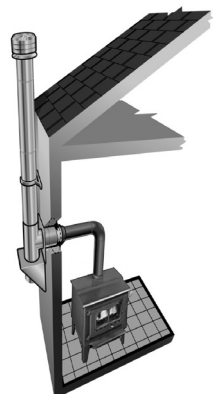



## Stainless Steel Chimney Lengths

### HEIGHT REQUIREMENTS

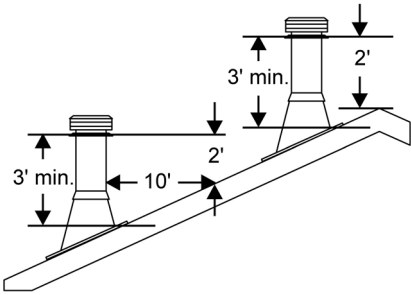

The chimney must extend at least three feet above the highest point where it passes through the roof surface and at least two feet higher than any part of the building within a horizontal distance of ten feet.

### CHIMNEY SECTIONS

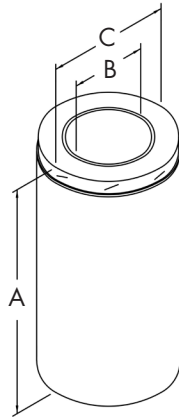

- Slim, advanced design allows for installation between 16" centers.
- A 2" clearance to combustible materials must be maintained at all times, except in areas protected by factory supplied support certified for reduced clearance.
- Secure twist-lock design couples chimney sections together with just a 1/8th turn.
- Sectional overlap of 1-1/8".
- Chimneys are sized according to the inner diameter and are available in 5", 6", 7" and 8".

Size	A	B	C	Product Code	Pack
5" x 36"	36"	5"	7"	JSC5SA3	1
5" x 24"	24"	5"	7"	JSC5SA2	1
5" x 18"	18"	5"	7"	JSC5SA18	1
5" x 12"	12"	5"	7"	JSC5SA1	1
5" x 6"	6"	5"	7"	JSC5SA6	2
6" x 36"	36"	6"	8"	JSC6SA3	1
6" x 24"	24"	6"	8"	JSC6SA2	1
6" x 18"	18"	6"	8"	JSC6SA18	1
6" x 12"	12"	6"	8"	JSC6SA1	1
6" x 6"	6"	6"	8"	JSC6SA6	2
7" x 36"	36"	7"	9"	JSC7SA3	1
7" x 24"	24"	7"	9"	JSC7SA2	1
7" x 18"	18"	7"	9"	JSC7SA18	1
7" x 12"	12"	7"	9"	JSC7SA1	1
7" x 6"	6"	7"	9"	JSC7SA6	2
8" x 36"	36"	8"	10"	JSC8SA3	1
8" x 24"	24"	8"	10"	JSC8SA2	1
8" x 18"	18"	8"	10"	JSC8SA18	1
8" x 12"	12"	8"	10"	JSC8SA1	1
8" x 6"	6"	8"	10"	JSC8SA6	2

## Stainless Steel Chimney Lengths continued

- Two flanges engage the curls in each end of the adjoining sections holding them securely together.
- Supplied with Captured Nut & Bolt.
- Locking Bands must be used:
  - on all sections that make up an offset.
  - on tee branch to attach a chimney length.
  - on any length suspended below the Cathedral or Roof Support.
- While Locking Bands are not required on other chimney lengths, their use is recommended for added safety and stability. It also provides a more attractive appearance.

### LOCKING BANDS

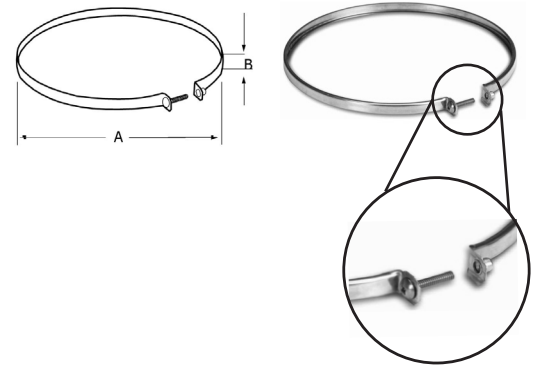

Size	A	B	Product Code	Pack
5"	7"	7/16"	JSC5SLB	5
6"	8"	7/16"	JSC6SLB	5
7"	9"	7/16"	JSC7SLB	5
8"	10"	7/16"	JSC8SLB	5

## Stainless Steel Tees and Elbows

### 15° OFFSET CHART

Offset		Height				Lengths Required						
5"	6"	7"	8"	5"	6"	7"	8"	6"	12"	18"	24"	36"
1-1/2	1-1/8	1-1/8	1-1/4	9	10	10-1/4	10-3/8	-	-	-	-	-
2-1/8	2-3/8	2-3/8	2-1/2	13-1/2	14-1/4	15	15-5/8	1	-	-	-	-
4	4	4	4	19-1/8	20-1/2	20-3/4	21	-	1	-	-	-
5-1/2	5-1/2	5-1/2	5-1/2	25	26-1/4	26-1/2	26-3/4	-	-	1	-	-
7-1/2	7	7	7	30-1/2	32	32-1/4	32-1/2	-	-	-	1	-
-	8-3/8	8-3/8	8-3/8	-	36-3/4	37	37-1/4	1	-	-	1	-
10-1/8	10-1/8	10-1/4	10-1/4	42	43-5/8	44	44-1/8	-	-	-	-	1
-	11-3/8	11-1/2	11-1/2	-	48-3/8	48-5/8	48-7/8	1	-	-	-	1
-	13	13	13	-	54-1/8	54-3/8	54-5/8	-	1	-	-	1
-	14-1/2	14-1/2	14-5/8	-	60	60-1/8	60-3/8	-	-	1	-	1
-	16-1/8	16-1/8	16-1/8	-	65-3/4	66	66-1/4	-	-	-	1	1
-	17-3/8	17-3/8	17-3/8	-	70-1/2	70-3/4	71	1	-	-	1	1
-	19	19	19	-	76-1/4	76-1/2	76-3/4	-	1	-	1	1
20	-	-	-	76	-	-	-	-	-	-	-	2

These charts have three columns for determining required lengths and elbows to achieve a desired offset.

The first column ("Offset") is the horizontal measurement, at the chimney center line, of the offset needed to get around an obstacle.

The second column ("Height") is the height of the assembled offset elbow to the top of the return elbow. Column 3 shows the appropriate lengths required.

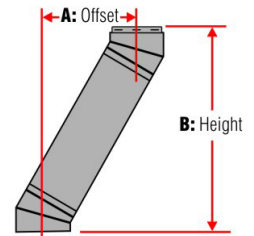

1. Determine the distance of the offset required.
2. On the chart, find the predetermined distance required for the elbow kit under the corresponding chimney diameter.
3. After finding the offset, follow across the chart to find the specified height and appropriate chimney lengths required under their corresponding diameters.

All measurements in inches. Offset tolerances  $\pm$  one inch.

### 30° OFFSET CHART

Offset		Height				Lengths Required						
5"	6"	7"	8"	5"	6"	7"	8"	6"	12"	18"	24"	36"
3	2-3/4	3-1/8	3-1/2	10	11-5/8	13	14-1/2	-	-	-	-	-
5-1/4	5-1/4	5-5/8	6	14	15-7/8	17-1/4	18-3/8	1	-	-	-	-
9	8-1/4	8-5/8	9	19-1/4	21	22-3/8	24	-	1	-	-	-
11-1/4	11-1/4	11-5/8	12	24-1/2	26-1/4	27-5/8	29-1/8	-	-	1	-	-
14-1/4	14-1/4	14-5/8	15	29-3/4	31-3/8	32-7/8	32-3/8	-	-	-	1	-
-	16-5/8	17	17-1/8	-	35-5/8	37	38-1/2	1	-	-	1	-
25-1/4	20-1/4	20-5/8	21	39-1/2	41-7/8	43-1/4	44-3/4	-	-	-	-	1
-	22-5/8	23	23-1/2	-	46	47-1/2	49	1	-	-	-	1
-	22-5/8	26	26-1/2	-	51-1/4	52-5/8	54-1/8	-	1	-	-	1
-	28-5/8	29	29-1/2	-	56-3/8	57-3/8	59-3/8	-	-	1	-	1
-	31-5/8	32	32	-	61-5/8	63	64-1/2	-	-	-	1	1
-	34-1/8	34-1/2	35	-	65-7/8	67-1/4	68-3/4	1	-	-	1	1
-	37-1/8	37-1/2	38	-	71	72-1/2	74	-	1	-	1	1
42	-	-	-	70	-	-	-	-	-	-	-	2

### 45° OFFSET CHART Canada Only

Offset		Height				Lengths Required						
5"	6"	7"	8"	5"	6"	7"	8"	6"	12"	18"	24"	36"
4-1/2	-	5	5-3/4	10-1/8	11	12	-	-	-	-	-	-
8	-	8-1/2	9-1/2	13-5/16	14-1/4	15	1	-	-	-	-	-
12-1/8	-	13-3/8	13	17-1/2	18-1/2	22-1/2	-	1	-	-	-	-
16-1/2	-	17	16-1/2	21-1/4	23	24-1/4	-	-	1	-	-	-
20-3/4	-	22	21-1/2	26-3/4	27	27-1/4	-	-	-	1	-	-
-	-	25-3/8	-	-	31-5/8	-	1	-	-	1	-	-
30-1/4	-	30-1/2	31	33-5/8	34-1/2	35-1/2	-	-	-	-	-	1
-	-	33-1/8	-	-	38-1/8	-	1	-	-	-	-	1
-	-	37	-	-	45-1/8	-	-	1	-	-	-	1
-	-	41-1/4	-	-	46-1/2	-	-	-	1	-	-	1
-	-	46-1/2	-	-	51-3/8	-	-	-	-	1	-	1
-	-	50	-	-	56-1/4	-	1	-	-	1	-	1
-	-	54-1/4	-	-	60-1/2	-	-	1	-	1	-	1
58	-	54-1/4	56	58-1/2	-	61-1/2	60-1/4	-	-	-	-	2

## INSULATED 15°, 30° AND 45° ELBOW KITS



- The Insulated Elbow is used when an offset is required.
- Locking Bands must be used on all elbows.
- A maximum of 6 feet is allowable between elbows.
- Elbow is fully insulated and can be used at the same 2" clearance as chimney lengths.
- Elbow support must be used with all offset installations.
- Elbows do not have locking ridges and can be rotated to attain optimum positioning, and allow chimney to return to correct vertical alignment, prior to installing Locking Bands.

### ELBOW KITS INCLUDE:

- 2 Elbows
- 4 Locking Bands
- 1 Elbow Support

### 15° ELBOW

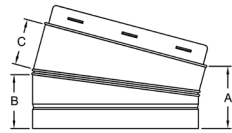

Size	A	B	C	Product Code	Pack
15° - 5"	3-3/8"	2-7/16"	1-15/16"	JSC5SEK	1
15° - 6"	3-3/8"	2-1/2"	2"	JSC6SEK	1
15° - 7"	3-3/8"	2-9/16"	2-1/16"	JSC7SEK	1
15° - 8"	3-3/8"	2-5/8"	2-1/8"	JSC8SEK	1

### 30° ELBOW

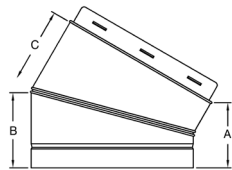

Size	A	B	C	Product Code	Pack
30° - 5"	2-3/4"	2-9/16"	2-9/16"	JSC5SE3K	1
30° - 6"	3-1/4"	3-1/16"	2-9/16"	JSC6SE3K	1
30° - 7"	3-3/4"	3-7/16"	2-15/16"	JSC7SE3K	1
30° - 8"	4-1/4"	3-7/8"	3-3/8"	JSC8SE3K	1

### 45° ELBOW

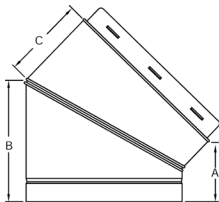

Size	A	B	C	Product Code	Pack
45° - 5"	1-15/16"	2-3/4"	2-3/8"	JSC5SE4K	1
45° - 6"	2-1/8"	3-1/8"	2-9/16"	JSC6SE4K	1
45° - 7"	2-3/8"	3-3/8"	3"	JSC7SE4K	1
45° - 8"	2-9/16"	3-3/4"	3-5/16"	JSC8SE4K	1

**NOTE:** 45° Elbows may be used in Canada only.



## Tee Components

- Insulated Tee is used for through-the-wall installation using a Wall Support.
- It allows the horizontal connection of the chimney to the appliance and provides access for inspection and cleaning.
- Includes uninsulated, twist-lock Tee Plug.

Size	A	B	C	D	E	Product Code	Pack
5"	7"	5"	10-1/2"	5"	5"	JSC5SITS	1
6"	8"	6"	11-1/2"	5-5/8"	5-3/4"	JSC6SITS	1
7"	9"	7"	12-1/4"	6-1/4"	6-3/16"	JSC7SITS	1
8"	10"	8"	13-3/8"	6-5/8"	6-1/2"	JSC8SITS	1

- Twist locks into bottom of Wall Support (AWS).
- Removable to provide easy access for chimney maintenance and inspection.
- Insulated to help maintain flue gas temperature.

Size	A	B	C	Product Code	Pack
5"	7"	5"	2-7/8"	J51TPI	1
6"	8"	6"	2-7/8"	J61TPI	1
7"	9"	7"	2-7/8"	J71TPI	1
8"	10"	8"	2-7/8"	J81TPI	1

- Replacement Non-Twist Insulated Tee Cap used with the WS Wall Support.
- Removable to provide easy access for chimney inspection and maintenance.
- Insulated to help maintain flue gas temperature.

Size	A	B	C	Product Code	Pack
5"	6-1/8"	4-31/32"	1-9/32"	SPR5NTITC	1
6"	7-1/8"	5-31/32"	1-9/32"	SPR6NTITC	1
7"	8-1/8"	6-31/32"	1-9/32"	SPR7NTITC	1
8"	9-1/8"	7-31/32"	1-9/32"	SPR8NTITC	1

## Supports

- Supports up to 38 feet of chimney. If chimney extends over 38 feet, Adjustable Intermediate Wall Support must also be used.
- Includes Wall Support top plate with female coupler attached, male adapter ring, side brackets and hardware.

Size	A	B	C	Product Code	Pack
5"	10"	17-1/8"	16"	JSC5AWS	1
6"	11"	17-1/8"	16"	JSC6AWS	1
7"	12"	17-1/8"	16"	JSC7AWS	1
8"	13"	17-1/8"	16"	JSC8AWS	1

### INSULATED TEE WITH PLUG

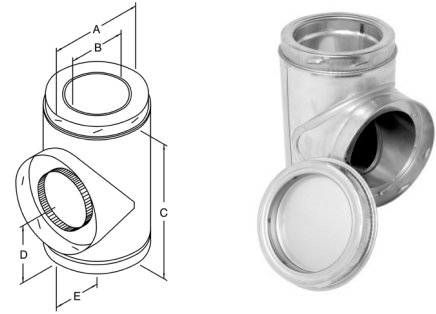

### INSULATED TEE PLUG

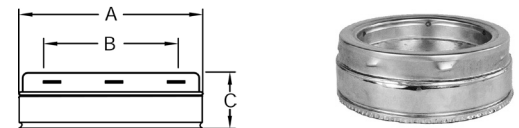

### NON-TWIST INSULATED TEE CAP

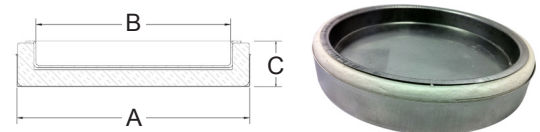

- For use with JSC/WS Wall Support.

### ADJUSTABLE WALL SUPPORT

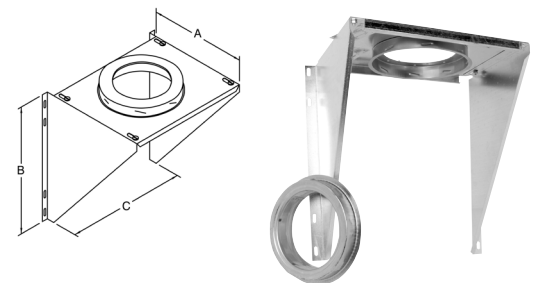

### ADJUSTABLE INTERMEDIATE WALL SUPPORT

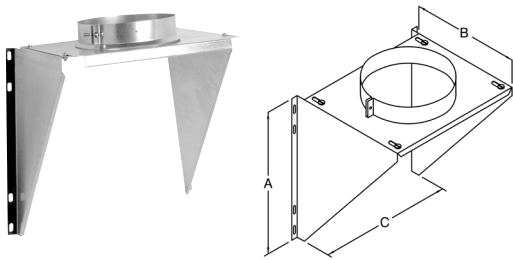

- Used as supplementary support when chimney system height exceeds maximum height allowed by Wall Support.
- Supports an additional 38 feet of chimney.
- Includes Top Plate, Support Band, Side Brackets and Hardware.

Size	A	B	C	Product Code	Pack
5"	17-1/8"	10"	16"	JSC5AIWS	1
6"	17-1/8"	11"	16"	JSC6AIWS	1
7"	17-1/8"	12"	16"	JSC7AIWS	1
8"	17-1/8"	13"	16"	JSC8AIWS	1

### ADJUSTABLE WALL SUPPORT WITH INSULATED TEE CAP

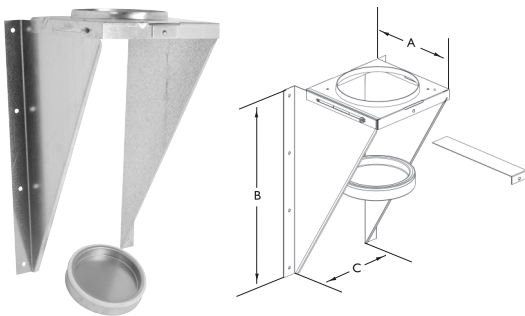

- Used to support chimney on a through-the-wall installation.
- Will support between 30 feet and 74 feet of chimney height based on size & distance from wall
- Adjustment of 2" to 6" from a vertical wall
- Includes wall support top plate, side brackets, hardware, non-twist lock insulated tee cap, and L-bracket to contain tee cap.

Size	A	B	C	Product Code	Pack
5"	10-5/8"	18-7/8"	12"	JSC5WS	1
6"	10-5/8"	18-7/8"	12"	JSC6WS	1
7"	11-5/8"	20-1/2"	13"	JSC7WS	1
8"	12-5/8"	21-7/8"	14"	JSC8WS	1

### DECORATOR CEILING SUPPORT-SPUN

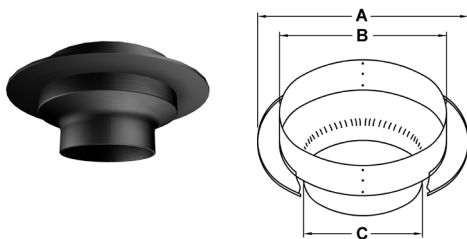

- Supports up to 50 feet of chimney.
- Matte black support gives a finished appearance.

Size	A	B	C	Product Code	Pack
6"	17-7/8"	12-3/8"	8-1/4"	JSC6DCSS	1
7"	17-7/8"	13-3/8"	9-1/4"	JSC7DCSS	1
8"	19-5/8"	14-3/8"	10-1/4"	JSC8DCSS	1

### DECORATOR CEILING SUPPORT

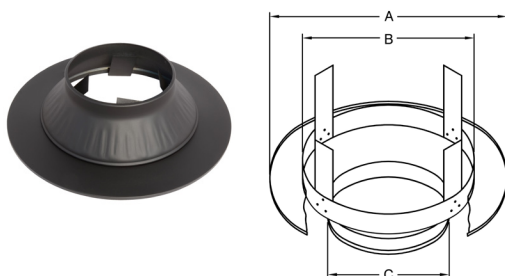

- Supports up to 50 feet of chimney
- Matte black finish gives a finished appearance.

Size	A	B	C	Product Code	Pack
5"	17-7/8"	11-3/8"	7-1/4"	SPR5CSB	1
6"	17-7/8"	12-3/8"	8-1/4"	JSC6DCS	1
8"	19-5/8"	14-3/8"	10-1/4"	JSC8DCS	1

## Supports continued

- Used in pitched ceiling support installations.
- Supports up to 38 feet of chimney.
- Includes 4 Trim pieces and Support Band.
- Matte black finish.

Size	A	B	C	Product Code	Pack
5"	7-3/16"	11"	17-1/2"	JSC5CCSB	1
6"	8-3/16"	12"	17-1/2"	JSC6CCSB	1
7"	9-3/16"	13"	17-1/2"	JSC7CCSB	1
8"	10-3/16"	14"	17-1/2"	JSC8CCSB	1

- The Roof Support adjusts to any roof pitch.
- It may be used above an offset to support the offset or as a supplementary support when the chimney height exceeds that of the primary support.
- Supports a total height of 50 feet of chimney.

Size	A	B	Product Code	Pack
5"	7"	5"	JSC5RS	1
6"	8"	5"	JSC6RS	1
7"	9"	5"	JSC7RS	1
8"	10"	5"	JSC8RS	1

## Shields

- The AIS must be installed where the chimney enters the attic space in any installation.
- When fully extended the AIS provides joist shielding.
- Designed to keep insulation away from the chimney, and to maintain the mandatory 2" clearance to combustibles.

Size	A	B	C	D	E	Product Code	Pack
5"	11"	7"	13"	11-13/16"	8-1/2"	JSC5AIS	1
6"	12"	8"	14"	11-13/16"	8-1/2"	JSC6AIS	1
7"	13"	9"	15"	11-13/16"	8-1/2"	JSC7AIS	1
8"	14"	10"	16"	11-13/16"	8-1/2"	JSC8AIS	1

- Also known as a Firestop Joist Shield.
- Required where the chimney passes from one living space to another living space or occupied attic space.
- Maintains the mandatory 2" clearance to combustibles.
- Shields the joist space from heat radiation.

Size	A	B	C	Product Code	Pack
5"	9"	19"	13"	JSC5FRS	1
6"	10"	19"	14"	JSC6FRS	1
7"	11"	19"	15"	JSC7FRS	1
8"	12"	19"	16"	JSC8FRS	1

### CATHEDRAL CEILING SUPPORT BOX

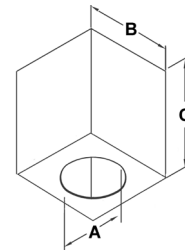

Add JUSI (pg. 16) to the Cathedral Ceiling Support for increased performance and safety.

### ROOF SUPPORT

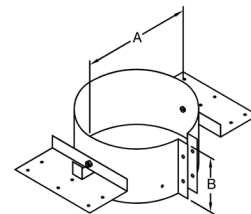

### ATTIC INSULATION SHIELD

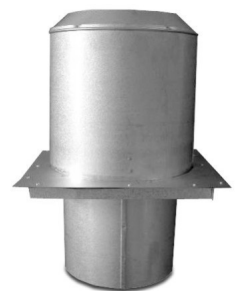
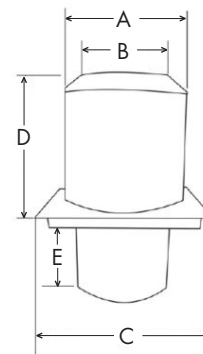

Add JUSI (pg. 16) to the Wall Thimble for increased performance and safety.

### FIRESTOP RADIATION SHIELD

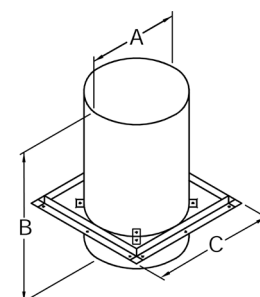

## RAFTER RADIATION SHIELD

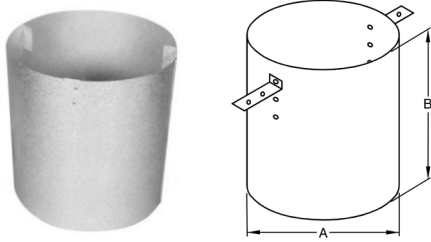

Must be installed where the chimney is enclosed immediately below the roof line.

Size	A	B	Product Code	Pack
5"	9"	12"	JSC5RRS	1
6"	10"	12"	JSC6RRS	1
7"	11"	12"	JSC7RRS	1
8"	12"	12"	JSC8RRS	1

## WALL THIMBLE

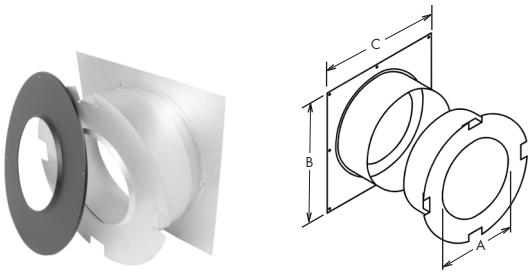

Add JUSI (pg. 16) to the Wall Thimble for increased performance and safety.

- Used in a wall support installation.
- Radiation shield is included with spacers which maintain the mandatory 2" clearance to combustibles.
- Attractive matte black finishing trim is included. (not shown in diagram).
- Extends to fit 8-3/4" wall thickness.

Size	A	B	C	Product Code	Pack
5"	7-1/8"	16"	16-1/8"	JSC5WT	1
6"	8-1/8"	16"	16-1/8"	JSC6WT	1
7"	9-1/8"	16"	16-1/8"	JSC7WT	1
8"	10-1/8"	16"	16-1/8"	JSC8WT	1

## Flashings and Storm Collars

### ROOF FLASHING SELECTION CHART

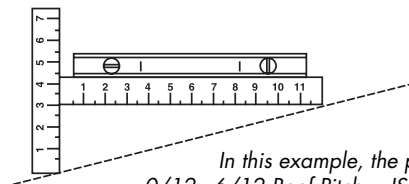

In this example, the pitch is 3/12.  
 0/12 - 6/12 Roof Pitch = JSC 6 or 7 AAF  
 6/12 - 12/12 Roof Pitch = JSC 6 or 7 AF2

To determine what Roof Flashing you'll require, you must work out the pitch of your roof. To determine the pitch, you'll need two rulers and a level. Measure the number of inches from the end of the level down to the roof.

### ADJUSTABLE FLASHING ASSEMBLY- FLAT TO 6/12

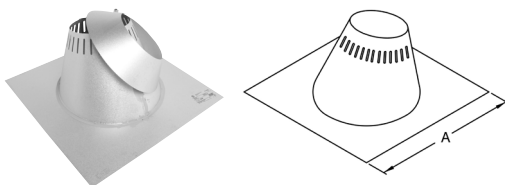

All roof flashings are constructed of corrosion resistant galvalume steel.

- Used where the chimney passes through a roof with a pitch of Flat to 6/12.
- Comes complete with Storm Collar.

Size	A	Product Code	Pack
5"	24" x 24"	JSC5AAF	1
5"	24" x 24"	JSC5AAF-3	3
6"	24" x 24"	JSC6AAF	1
6"	24" x 24"	JSC6AAF-3	3
7"	24" x 24"	JSC7AAF	1
7"	24" x 24"	JSC7AAF-3	3
8"	27-1/2" x 27-1/2"	JSC8AAF	1
8"	27-1/2" x 27-1/2"	JSC8AAF-3	3

## Flashings and Storm Collars continued

- Used where the chimney passes through a roof with a pitch of 6/12 to 12/12.
- Comes complete with Storm Collar.

Size	A	Product Code	Pack
5"	30" x 21-1/2"	JSC5AF2	1
5"	30" x 21-1/2"	JSC5AF2-3	3
6"	30" x 21-1/2"	JSC6AF2	1
6"	30" x 21-1/2"	JSC6AF2-3	3
7"	30" x 21-1/2"	JSC7AF2	1
7"	30" x 21-1/2"	JSC7AF2-3	3
8"	30" x 21-1/2"	JSC8AF2	1
8"	30" x 21-1/2"	JSC8AF2-3	3

- Used on flat roof surfaces.
- Comes complete with Storm Collar.

Size	A	B	Product Code	Pack
5"	24"	12"	JSC5ATC	1
6"	24"	12"	JSC6ATC	1
7"	24"	12"	JSC7ATC	1
8"	27"	12"	JSC8ATC	1

- Available in 7" only.
- Required where the chimney passes through a peaked roof with a pitch of 3/12 to 6/12.
- Comes complete with Storm Collar.

Size	A	B	Product Code	Pack
7"	22"	10"	JSC7P1	1

- Available in 7" only.
- Required where the chimney passes through a peaked roof with a pitch of 7/12 to 9/12.
- Comes complete with Storm Collar.

Size	A	B	Product Code	Pack
7"	20"	14"	JSC7P2	1

### ADJUSTABLE FLASHING 6/12 TO 12/12

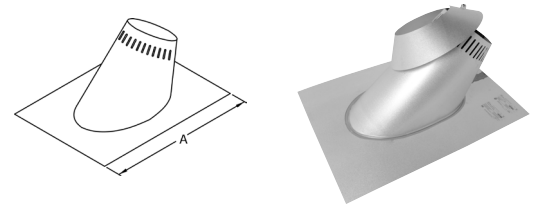

All roof flashings are constructed of corrosion resistant galvalume steel

### TALL CONE FLASHING FLAT TO 1/12

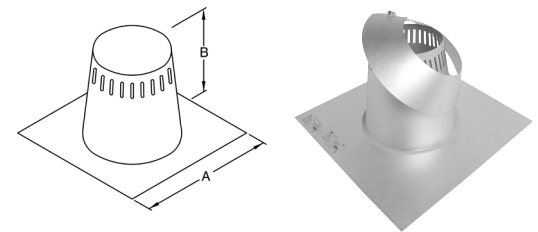

All roof flashings are constructed of corrosion resistant galvalume steel

### PEAK FLASHING 3/12 TO 6/12

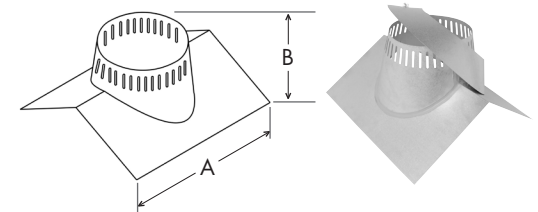

All roof flashings are constructed of corrosion resistant galvalume steel

### PEAK FLASHING 7/12 TO 9/12

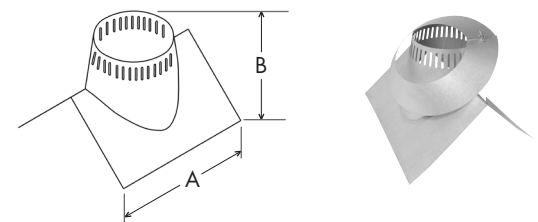

All roof flashings are constructed of corrosion resistant galvalume steel

### RUBBER BOOT FLASHING KIT



**THIS KIT INCLUDES:**

- Special Storm Collar
- Rubber Boot.
- Spacer Kit.
- Special Boot Mounting Screws

- This kit fits 5", 6", 7" and 8" Chimneys.
- Used where the chimney passes through a corrugated roof.
- Rubber Boot Flashing fits roof pitches up to 12/12" (10/12 for 8").

Size	Product Code	Pack
ALL	JURBFK-1	1

### ALUMINUM STORM COLLAR

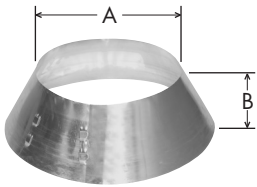

Used in conjunction with Roof Flashing to keep precipitation out.

Size	A	B	Product Code	Pack
5"	7"	5-1/2"	JSC56ASC-1	1
6"	8"	5-1/2"	JSC56ASC-1	1
7"	9"	5-1/2"	JSC78ASC-1	1
8"	10"	5-1/2"	JSC78ASC-1	1

### SILICONE SEALANT FOR STORM COLLAR



- Used to seal Storm Collar to chimney length above cone of flashing.
- 3 ounce tube.

Size	Product Code	Pack
3 ounce tube	JRTV	1

## Rain Caps

### STANDARD RAIN CAP

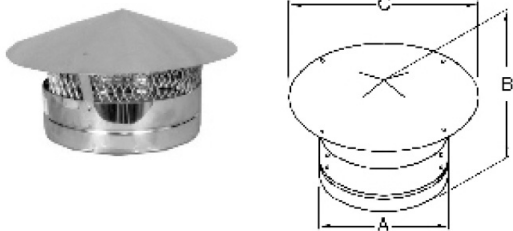

- Designed to allow free flow of air and used in conjunction with Spark Arrestor (sold Separately) to prevent access to flue by foreign objects.

Size	A	B	C	Product Code	Pack
5"	7"	7-1/2"	11-1/4"	JSC5RC	1
6"	8"	7-1/2"	12-1/4"	JSC6RC	1
7"	9"	7-1/2"	13-1/4"	JSC7RC	1
8"	10"	7-1/2"	14-1/4"	JSC8RC	1

### DELUXE RAIN CAP

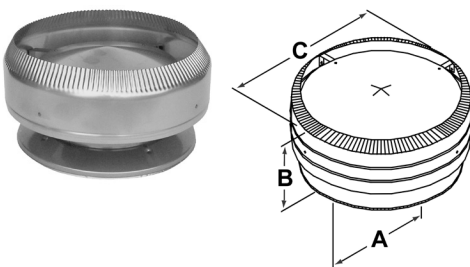

- Advanced design.
- Provides protection against precipitation and creates a venturi effect to enhance draught.
- Twist-lock connection for secure installation.

Size	A	B	C	Product Code	Pack
5"	7"	7-1/2"	12-1/4"	JSC5DRC	1
6"	8"	7-1/2"	13-1/4"	JSC6DRC	1
7"	9"	7-1/2"	14-1/4"	JSC7DRC	1
8"	10"	7-1/2"	15-1/4"	JSC8DRC	1

Stainless steel mesh wire fits inside Rain Cap (JSC\*RC).

Size	Dimensions	Product Code	Pack
5"	4-1/2" x 26"	JSC5SPAR	10
6"	4-1/2" x 26"	JSC6SPAR	10
7"	4-1/2" x 29"	JSC7SPAR	10
8"	4-1/2" x 32"	JSC8SPAR	10

## SPARK ARRESTOR

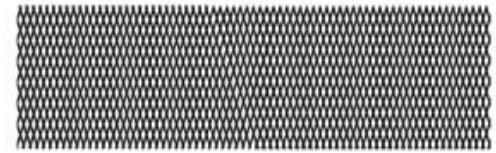

## Parts and Accessories

- Provides lateral support for the chimney when installed adjacent to a wall.
- Maintains the mandatory 2" clearance to combustibles.
- Installed on first length above the Tee, then every 8 feet thereafter.

Size	A	B	Product Code	Pack
5"	7"	17"	JSC5WB	5
6"	8"	17"	JSC6WB	5
7"	9"	17"	JSC7WB	5
8"	10"	17"	JSC8WB	5

## WALL BAND

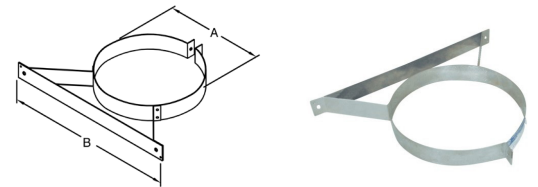

- For use with free-standing wood stoves for quick and easy transition from black stove pipe or Double Wall black stove pipe to factory-built chimney.
- Twist-lock for easy connection to the chimney.
- Stainless steel.

Size	A	B	C	Product Code	Pack
5"	7"	5"	5"	JSC5ASE	1
6"	8"	6"	5"	JSC6ASE	1
7"	9"	7"	5"	JSC7ASE	1
8"	10"	8"	5"	JSC8ASE	1

## STOVE PIPE ADAPTER

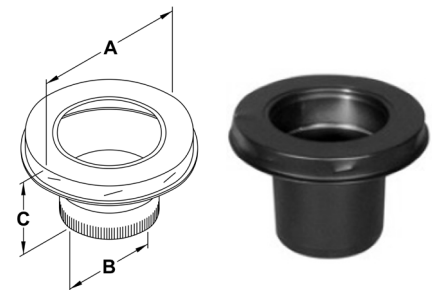

- Used where the chimney passes through a soffit to provide a finished appearance.
- Maintains the mandatory 2" clearance to combustibles.

Size	A	B	Product Code	Pack
5"	7-1/8"	13"	JSC5FP	1
6"	8-1/8"	14"	JSC6FP	1
7"	9-1/8"	15"	JSC7FP	1
8"	10-1/8"	16"	JSC8FP	1

## FINISHING PLATE

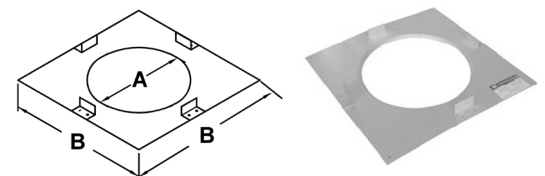

### BLACK TRIM COLLAR

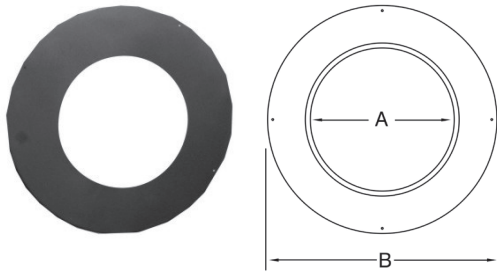

- Used on wall support installations when passing through a non-combustible wall.
- Matte black finish.

Size	A	B	Product Code	Pack
5"	7"	16"	J5TC	1
6"	8"	16"	J6TC	1
7"	9"	16"	J7TC	1
8"	10"	16"	J8TC	1

### UNIVERSAL ROOF GUY KIT

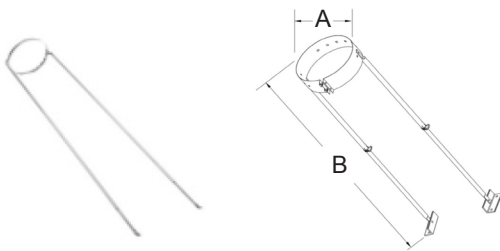

- Used when 5 feet or more of chimney extends above the roof.
- The kit includes two 4 foot rods and an adjustable band.
- Each rod extends to approximately 7-1/2 feet.
- The adjustable band will fit 5", 6", 7" and 8" diameter chimney.

Size	A	B	Product Code	Pack
5"	7" - 10"	48" - 84"	JURGK-1	1
6"	7" - 10"	48" - 84"	JURGK-1	1
7"	7" - 10"	48" - 84"	JURGK-1	1
8"	7" - 10"	48" - 84"	JURGK-1	1

### JUSI-UNIVERSAL SHIELDING INSULATION

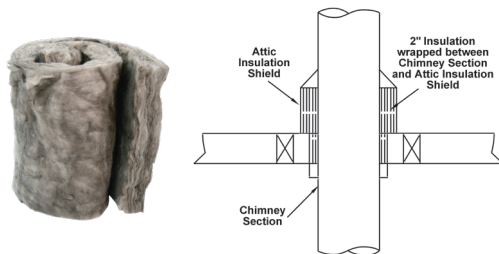

- Insulation for use with:
  - Attic Insulation Shield (JSC\* AIS)
  - Wall Thimble (JSC\*WT)
  - Cathedral Ceiling Support (JSC\*CCSB)
- Reduces cold air infiltration into the dwelling.
- Provides additional protection against heat from the chimney.

Size	Dimensions	Product Code	Pack
Universal	48" x 12" x 2"	JUSI	1



## Fireplace Parts

Used with specific factory-built fireplaces listed to UL 127 or CAN/ULC-S610.

Size	A	B	Product Code	Pack
5"	7"	11-5/8"	JSC5AP	1
6"	8"	11-5/8"	JSC6AP	1
7"	9"	11-5/8"	JSC7AP	1
8"	10"	11-5/8"	JSC8AP	1

- Recommended to reduce air infiltration through the chase in cold climates.
- Maintains the thermal envelope of your home.
- Trim plate is provided when a 6" chimney is used.

Size	A	B	C	Product Code	Pack
6" & 7"	17"	17"	4"	JSC7CP	1

- For use where the chimney passes through a wall at a 30° or 45° angle.
- Maintains the thermal envelope of your home.
- A trim plate is provided when a 6" diameter chimney is used and a 45° angle is requested.

Size	A	B	C	Product Code	Pack
6" & 7"	17"	34"	4"	JSC7WC	1

For use where the chimney passes through a wall at a 45° angle.

Size	A	B	Product Code	Pack
7"	31"	15"	JSC7WFP4	1

### ADAPTOR PLATE

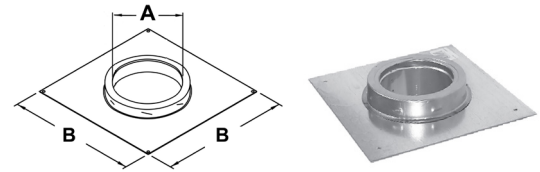

### INSULATED CHASE PLUG

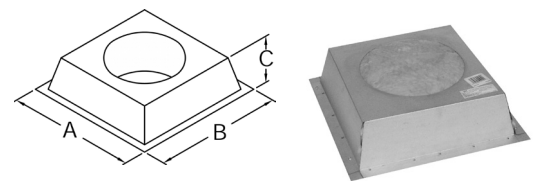

### INSULATED 30° / 45° OFFSET WALL PLUG

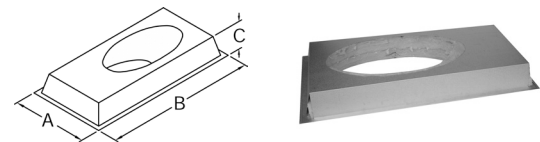

### 45° FACE PLATE

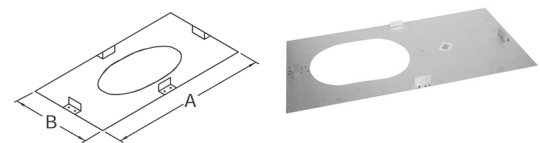



**Notes**



A series of horizontal red lines spanning the width of the page, providing a template for handwritten notes.

# SUPERVENT<sup>®</sup>

For training, detailed product information, downloadable catalogs and installation instructions visit our website:

[selkirkcorp.ca](http://selkirkcorp.ca)



**Selkirk Canada Inc.**  
P.O. Box 526, Depot 1  
Hamilton, ON L8L 7X6

phone: 1.888.SELKIRK (735.5475)  
email: [cscanada@selkirkcorp.com](mailto:cscanada@selkirkcorp.com)

Complete Linecard



residential chimney



roof curbs & equipment rails



access doors



rooftop products



residential vent



grilles, registers, diffusers



commercial industrial vent