

FUEL TYPE:

Gas | Oil | Wood | Coal



TABLE OF CONTENTS

Typical Installation 3

Technical Data Sheet 4

Stainless Steel Chimney Lengths 5

Stainless Steel Elbows and Tees..... 6-8

Supports 8-9

Shields..... 10-11

Flashings and Storm Collars 12-13

Rain Caps 14

Parts and Accessories 14-15

Support Kits..... 16

Typical Installation

CEILING SUPPORT INSTALLATIONS

One Story

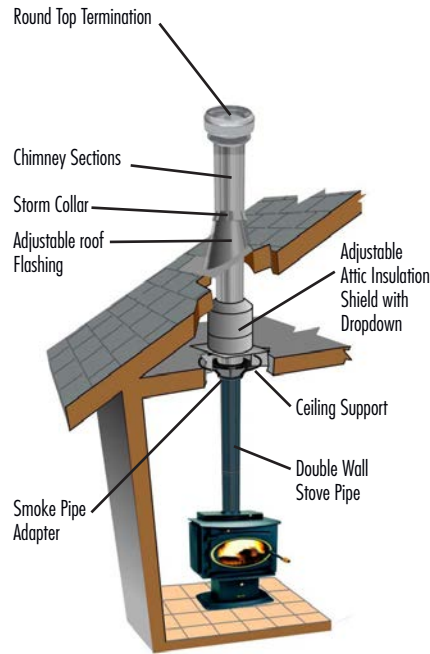

Two Story

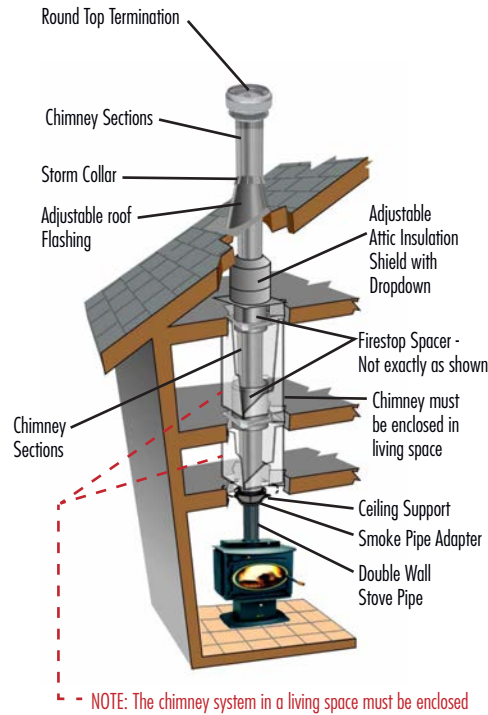

Elbow Installation

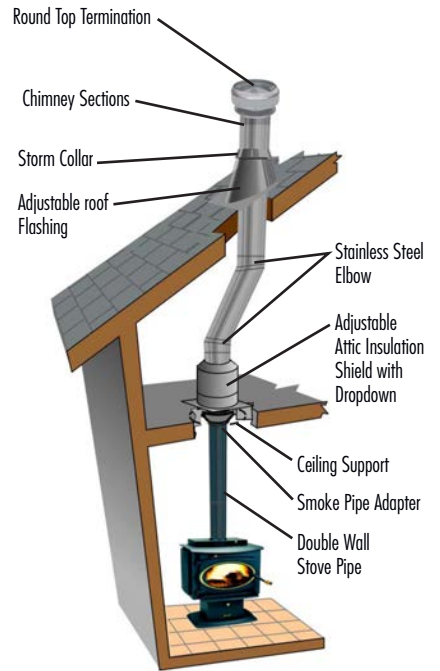

CEILING SUPPORT INSTALLATIONS

With Cathedral Ceiling Support Box

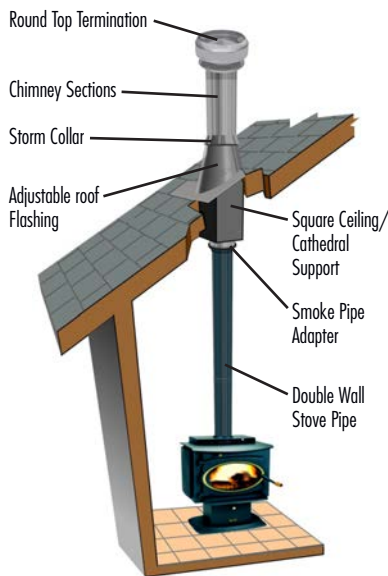

WALL SUPPORT INSTALLATIONS

One Story

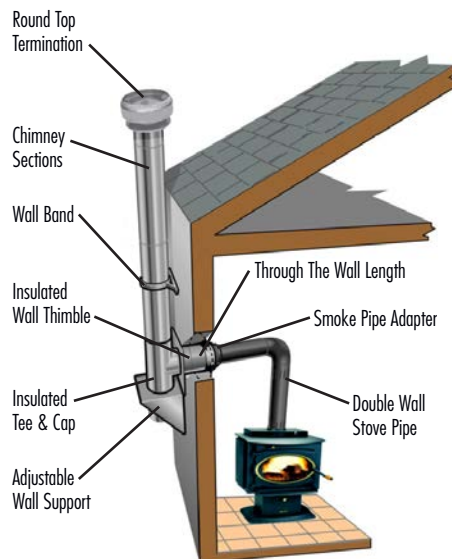

Through a Soffit

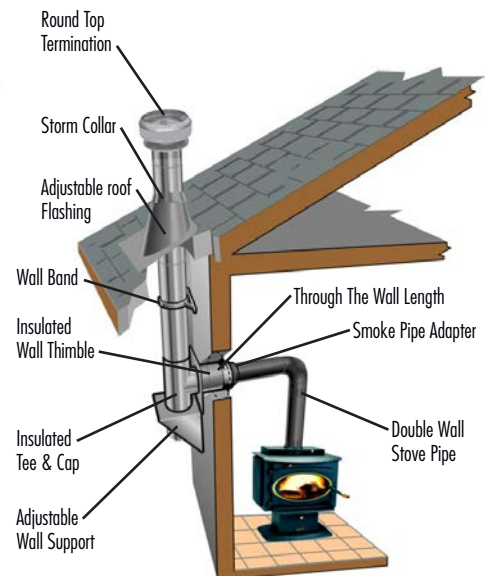



SuperVent 2100 Premium Grade Stainless Steel Chimney

FOR THE CHIMNEY PROFESSIONAL WHO DEMANDS THE BEST...

Hi-Tech Chimney For Hi-Tech Wood Stoves

The SuperVent 2100 is designed for today's Wood Stoves which are engineered to produce low emissions, provide less heat up the chimney and more heat into the room. A high insulating value allows SuperVent 2100 to maintain a strong draft, even when faced with these low stack temperatures. This makes SuperVent 2100 the choice of professionals who are looking for a better quality, factory built chimney system.

Test Standards

SuperVent 2100 has been tested and listed to ULC standard CAN/ULC-S629 requiring this system to withstand temperatures of up to 2100° F (1150°C) for three, thirty minute intervals. SuperVent 2100 chimney is also listed and tested to Type HT requirements of Underwriters Laboratories, Inc., Standard ANSI/UL 103 HT. SuperVent 2100 chimney conforms to the installation code for solid fuel burning appliances CSA B365. The minimum clearances shown are proven safe during the fire tests conducted with the component supports and spacers in actual contact with combustible framing. Proper installation must be followed with the instructions provided using each support assembly. Although primarily used in venting solid fuel applications, SuperVent 2100 is an all-fuel chimney also intended for venting gas or liquid fuel residential type appliances and building heating appliances.

Premium Supports

Deluxe chimney support components will enhance any installation.

Supports/Framing

All SuperVent 2100 Supports are designed to carry four times the combined weight of each system at maximum allowable height.

Support and Framing Dimensions Table

Support*	Ceiling Support	Wall Support	Cath. Ceiling Support	Roof Support
	40'	33'	18'	39'
Diameter	Framing Dimensions			
6" Dia.	14-3/8" x 14-3/8"	14-3/8" x 14-3/8"	14" x 14"	14" x 14"
7" Dia.	14-3/8" x 14-3/8"	14-3/8" x 14-3/8"	15" x 15"	15" x 15"
8" Dia.	14-3/8" x 14-3/8"	14-3/8" x 14-3/8"	16" x 16"	16" x 16"

Smart Choice Lifetime Warranty

The SuperVent 2100 Smart Choice Lifetime Warranty applies to all Chimney components (not just insulated lengths) making SuperVent 2100 chimney the smart choice, every time. (See written Warranty for details).

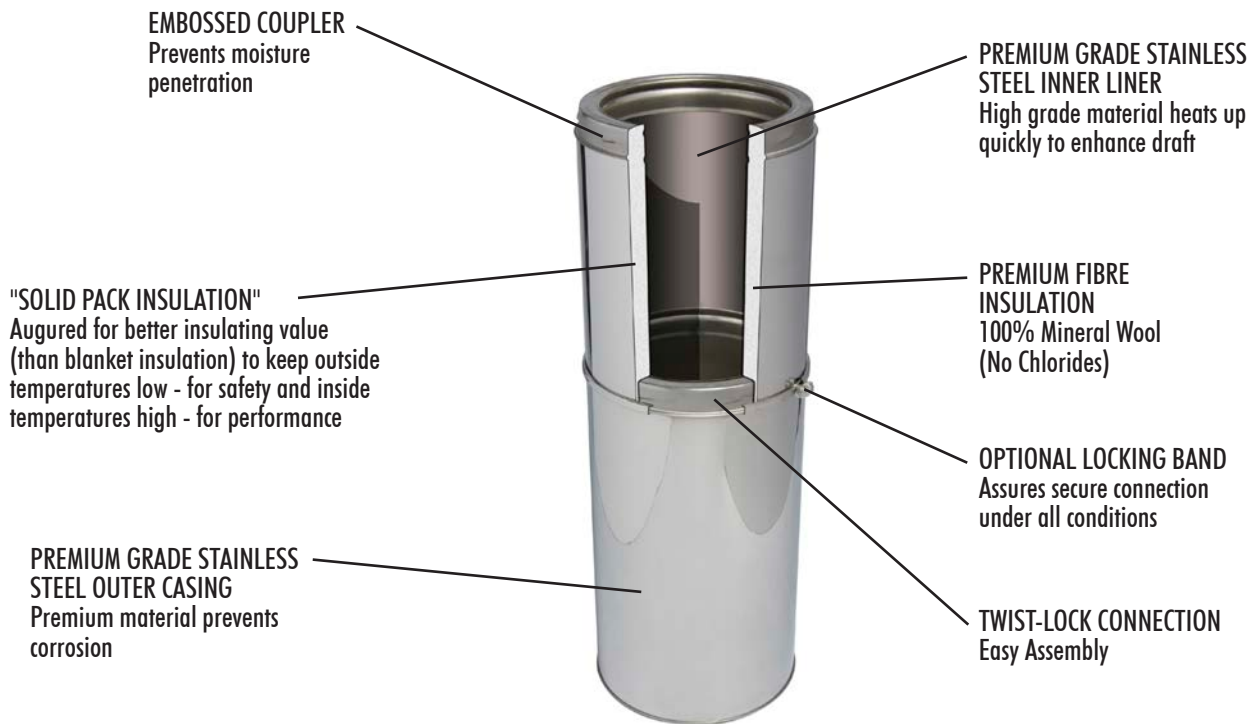

Not exactly as shown



Smart Choice Lifetime Warranty

The SuperVent 2100 Smart Choice Lifetime Warranty applies to all Chimney components (not just insulated lengths) making SuperVent 2100 chimney the smart choice, every time. (See written Warranty for details)

Stainless Steel Chimney Lengths

The chimney must extend at least three feet above the highest point where it passes through the roof surface and at least two feet higher than any part of the building within a horizontal distance of ten feet.

HEIGHT REQUIREMENTS

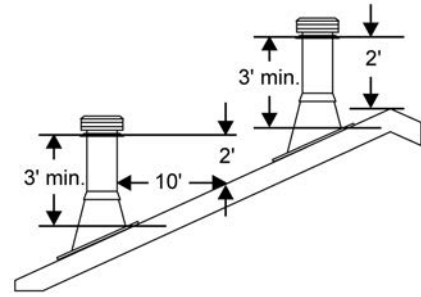

- Available in 36", 24", 18", 12" and 6" lengths.
- SuperVent 2100 has a 2" wall thickness.
- Secure twist-lock design couples chimney sections together with just a 1/8 turn.
- Sectional overlap of 1-1/8".
- Chimneys are sized according to the inner diameter and are available in 6, 7, & 8 inch diameters.
- Insulated chimney requires 2" clearance to combustible material.

CHIMNEY SECTIONS

Size	A	B	C	Product Code	Pack
6" x 36"	36"	6"	10"	JM6S36	1
6" x 24"	24"	6"	10"	JM6S24	1
6" x 18"	18"	6"	10"	JM6S18	1
6" x 12"	12"	6"	10"	JM6S12	1
6" x 6"	6"	6"	10"	JM6S6	2
7" Diameter					
7" x 36"	36"	7"	11"	JM7S36	1
7" x 24"	24"	7"	11"	JM7S24	1
7" x 18"	18"	7"	11"	JM7S18	1
7" x 12"	12"	7"	11"	JM7S12	1
7" x 6"	6"	7"	11"	JM7S6	2
8" Diameter					
8" x 36"	36"	8"	12"	JM8S36	1
8" x 24"	24"	8"	12"	JM8S24	1
8" x 18"	18"	8"	12"	JM8S18	1
8" x 12"	12"	8"	12"	JM8S12	1
8" x 6"	6"	8"	12"	JM8S6	2

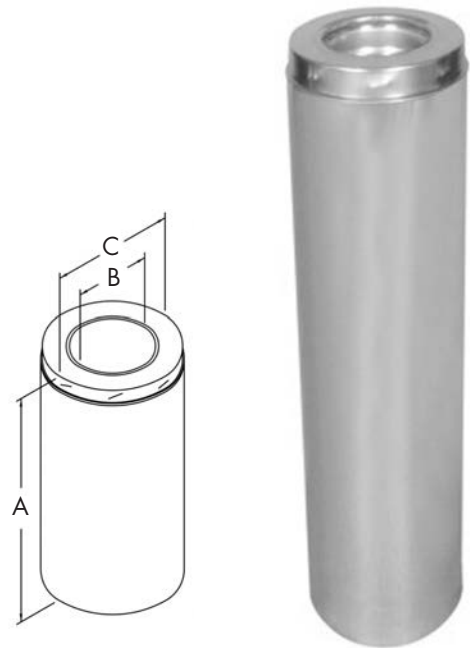

LOCKING BANDS

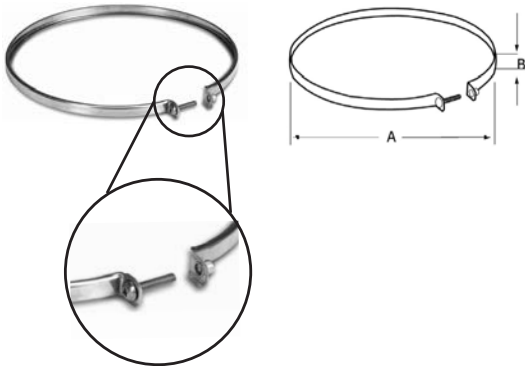

- Two flanges engage the curls in each end of the adjoining sections holding them securely together.
- Supplied with Captured Nut & Bolt.
- Locking Bands must be used:
 - on all sections that make up an offset.
 - on tee branch to attach a chimney length.
 - on any length suspended below the Cathedral or Roof Support.
- While Locking Bands are not required on other chimney lengths, their use is recommended for added safety and stability. It also provides a more attractive appearance.

Size	A	B		Product Code	Pack
6"	10"	7/16"		JM6SLB	5
7"	11"	7/16"		JM7SLB	5
8"	12"	7/16"		JM8SLB	5

Stainless Steel Elbows and Tees

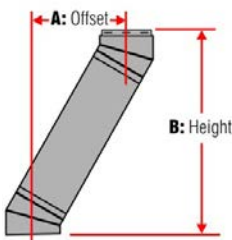

This chart has three columns for elbow angle required to achieve your desired offset.

The first column ("Offset") is the horizontal measurement, at the chimney center line, of the offset needed to get around an obstacle. The second column ("Height") is the height of the assembled offset elbow to the top of the return elbow. Column 3 shows the appropriate lengths required.

1. Determine the distance of the offset required.
2. On the chart, find the predetermined distance required for the 15° elbow kit under the corresponding chimney diameter. For greater offset, use the 30° or 45° elbow kit.
3. After finding the offset, follow across the chart to find the specified height and appropriate chimney lengths required under their corresponding diameters.

All measurements in inches. Offset tolerances ± one inch.

15° OFFSET CHART											
Offset	Height			Lengths Required							
	6"	7"	8"	6"	7"	8"	6"	12"	18"	24"	36"
1-1/4	1-15/16	1-5/8	10-5/8	11	11-3/8						
2-1/16	2-1/4	2-1/2	15-3/8	15-3/4	15-3/4	1					
4-1/16	4-1/8	4-1/8	21-1/4	21-1/2	21-13/16		1				
5-5/8	5-11/16	5-11/16	27-3/16	27-3/8	27-5/8			1			
7-1/4	7-1/4	7-1/4	33	33-1/8	33-3/8				1		
8-7/16	8-3/8	8-1/2	37-5/8	37-7/8	38-3/16	1	1	1			
10-1/4	10-1/4	10-3/8	44-1/2	44-3/4	45-1/16						1
11-1/2	11-1/2	11-11/16	49-1/4	49-3/8	49-3/4	1		1	1		
13-1/8	13	13-1/4	55	55-1/4	55-5/8		1				1
14-11/16	14-1/2	14-3/4	60-3/4	61-1/4	61-5/8			1			1
16-1/4	16-1/8	15-5/16	66-3/4	66-7/8	67-1/8					1	1
17-1/2	17-3/8	17-1/2	71-11/16	71-5/8	71-3/4	1	1	1			1
19	19	19	77-5/16	77-9/16	77-11/16		1		1		1

30° OFFSET CHART											
Offset	Height			Lengths Required							
	6"	7"	8"	6"	7"	8"	6"	12"	18"	24"	36"
3-9/16	3-3/4	3-7/8	14-3/16	15-1/2	15-3/8						
5-7/8	6-1/4	6-3/8	18-5/16	19-1/2	19-3/4	1					
8-7/8	9-1/4	9-3/8	23-9/16	24-3/4	25		1				
11-15/16	12-5/16	12-7/8	28	29-13/16	30-1/16			1			
14-15/16	15-5/16	15-7/16	34-1/16	35-3/8	35-1/4				1		
17-5/16	17-5/8	17-9/16	38-5/16	39-3/16	39-5/8	1	1	1			
20-7/8	21-1/4	21-7/16	44-9/16	45-5/8	46-1/16					1	
23-5/16	23-11/16	23-7/8	48-15/16	49-3/4	50-3/16	1		1	1		
26-5/16	26-11/16	26-7/8	54-1/8	54-15/16	55-9/16		1			1	
29-5/16	29-11/16	29-9/16	59-5/16	60-1/8	60-3/4			1		1	
32-5/16	32-9/16	32-5/8	64-3/8	64-5/8	65-1/4				1		1
34-5/8	35-1/8	35	68-1/2	68-3/4	69	1	1	1			1
37-13/16	38-1/8	38	73-13/16	74-1/16	74-5/16		1		1	1	

45° OFFSET CHART											
Offset	Height			Lengths Required							
	6"	7"	8"	6"	7"	8"	6"	12"	18"	24"	36"
5-11/16	6	6-1/4	14-13/16	15-9/16	16-1/4						
9-1/4	9-1/2	9-13/16	18-3/8	19-1/16	19-13/16	1					
13-1/2	13-3/4	14-1/16	22-5/8	23-5/16	24		1				
17-11/16	18	18-5/16	26-7/8	27-9/16	28-1/4			1			
21-15/16	22-1/4	22-9/16	31-1/8	31-13/16	32-1/2				1		
30-7/16	30-3/4	31	39-9/16	40-5/16	41					1	
34	34-1/4	34-9/16	43-1/8	43-13/16	44-9/16	1					1
38-3/16	38-1/2	38-13/16	47-3/8	48-1/16	48-3/4		1				1
42-7/16	42-3/4	43-1/16	51-5/8	52-5/16	53			1			1
46-11/16	47	47-5/16	55-7/8	56-9/16	57-1/4				1		1
55-3/16	55-1/2	55-3/4	64-5/16	65-1/16	65-3/4					1	1

Stainless Steel Elbows and Tees *continued*

- The Insulated Elbow is used when an offset is required.
- Locking Bands must be used on all elbows.
- Offsets cannot be more than 45° off the vertical.
- A maximum of 6 feet is allowable between elbows.
- Elbow is fully insulated and can be used at the same 2" clearance as chimney lengths.
- Elbow support must be used with all offset installations.
- Elbows do not have locking ridges and can be rotated to attain optimum positioning, and allow chimney to return to correct vertical alignment, prior to installing Locking Bands.

NOTE: The Firestop Spacer (JM*FS) is a required component when using 45° Elbow Kit.

Size	A	B	C	Product Code	Pack
15° - 6"	3-7/16"	2-1/2"	2"	JM6SEK	2
15° - 7"	3-7/16"	2-9/16"	2-1/16"	JM7SEK	2
15° - 8"	3-7/16"	2-5/8"	2-1/8"	JM8SEK	2

Size	A	B	C	Product Code	Pack
30° - 6"	4-1/4"	3-3/4"	3-1/8"	JM6SE3K	2
30° - 7"	4-1/4"	3-3/4"	3-1/2"	JM7SE3K	2
30° - 8"	4-1/4"	3-3/4"	3"	JM8SE3K	2

Size	A	B	C	Product Code	Pack
45° - 6"	2-1/8"	3-1/8"	2-9/16"	JM6SE4K	2
45° - 7"	2-3/8"	3-3/8"	3"	JM7SE4K	2
45° - 8"	2-9/16"	3-3/4"	3-5/16"	JM8SE4K	2

- The insulated chimney tee is used for through-the-wall installation using a wall support.
- A chimney length is attached to the tee branch using a Locking Band to pass safely through a wall.
- Supplied with uninsulated Tee Plug.

Size	A	B	C	D	E	Product Code	Pack
6"	10"	6"	13-1/4"	6-1/2"	6-1/2"	JM6SIT	1
7"	11"	7"	14-1/4"	7"	7"	JM7SIT	1
8"	12"	8"	15-1/4"	7-1/2"	7-1/2"	JM8SIT	1

- Twist locks into bottom of Adjustable Wall Support.
- Removable to provide easy access for chimney maintenance or inspection.
- Insulated to help maintain flue gas temperature.

Size	A	B	C	Product Code	Pack
6"	10"	6"	3"	J62TPI	1
7"	11"	7"	3"	J72TPI	1
8"	12"	8"	3"	J82TPI	1

INSULATED 15°, 30° AND 45° ELBOW KITS

THIS KIT INCLUDES:

- 2 Elbows
- 4 Locking Bands
- 1 Elbow Support

NOTE: A Corner Shield Plate is supplied with the 45° Elbow Kit.



15° ELBOW

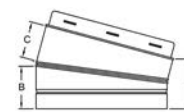

30° ELBOW

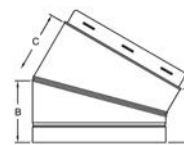

45° ELBOW

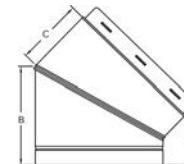

INSULATED TEE WITH PLUG

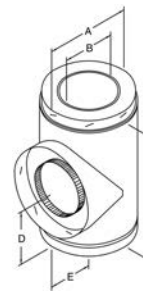

INSULATED TEE PLUG

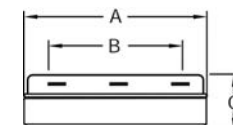

NON-TWIST INSULATED TEE CAP



- Replacement Non-Twist Lock Insulated Tee Cap used with the WS Wall Support.
- Removable to provide easy access for chimney inspection and maintenance.
- Insulated to help maintain flue gas temperature.

Size	A	B	C	Product Code	Pack
6"	7-1/16"	6-1/16"	1-17/64"	SPR6NTITC	1
7"	8-1/16"	7-1/16"	1-17/64"	SPR7NTITC	1
8"	9-1/16"	8-1/16"	1-17/64"	SPR8NTITC	1

Supports

ADJUSTABLE WALL SUPPORT

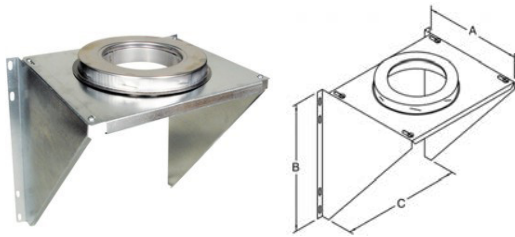

- Used to support the chimney on a wall installation.
- Supports up to 33 feet of chimney. If chimney extends over 33 feet, Adjustable Intermediate Wall Support must also be used.
- Includes wall support top plate with female coupler attached, male coupler, side brackets and hardware.

Size	A	B	C	Product Code	Pack
6"	13"	17-1/8"	16"	JM6AWS	1
7"	14"	17-1/8"	16"	JM7AWS	1
8"	15"	17-1/8"	16"	JM8AWS	1

ADJUSTABLE INTERMEDIATE WALL SUPPORT

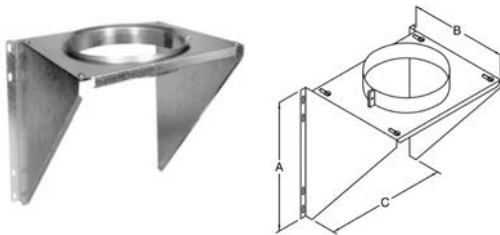

- Used as supplementary support when chimney system height exceeds maximum height allowed by wall support.
- Supports an additional 33 feet of chimney.
- Includes Top Plate, Support Band, Side Brackets and Hardware.

Size	A	B	C	Product Code	Pack
6"	17-1/8"	13"	16"	JM6AIWS	1
7"	17-1/8"	14"	16"	JM7AIWS	1
8"	17-1/8"	15"	16"	JM8AIWS	1

ADJUSTABLE WALL SUPPORT WITH INSULATED TEE CAP

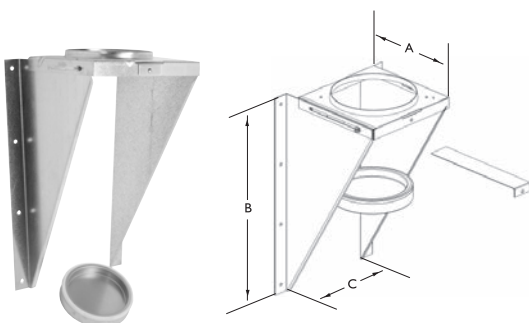

- Used to support chimney on a through-the-wall installation.
- Will support between 16 feet and 34 feet of chimney height based on size & orientation from wall.
- Adjustment of 2" to 6" from a vertical wall.
- Includes wall support top plate, side brackets, hardware, non-twist lock insulated tee cap, and L-bracket to contain tee cap.

Size	A	B	C	Product Code	Pack
6"	11-1/4"	21-7/8"	11-1/2"	JM6WS	1
7"	12-1/4"	23-9/16"	12-1/2"	JM7WS	1
8"	13-1/4"	25-1/4"	13-1/2"	JM8WS	1

Supports continued

- Used in pitched ceiling support installations.
- Supports up to 18 feet of chimney.
- Matte black finish.
- Includes 4 Trim Angles for an attractive interior finish.

Size	A	B	C	Product Code	Pack
6"	10-3/16"	14"	17"	JM6CCSB	1
7"	11-3/16"	15"	17"	JM7CCSB	1
8"	12-3/16"	16"	17"	JM8CCSB	1

- The Roof Support may be used on a floor, ceiling or roof and adjusts to any roof pitch.
- It may be used above an offset to support the offset or as a supplementary support when the chimney height exceeds that of the primary support.
- The Roof Support will support a total height of 39 feet of chimney.

Size	A	B	Product Code	Pack
6"	10"	5"	JM6RS	1
7"	11"	5"	JM7RS	1
8"	12"	5"	JM8RS	1

- For use in flat ceiling support installations.
- Supports up to 40 feet of chimney.
- Matte black finish gives a premium finished appearance.

Size	A	B	C	Product Code	Pack
6"	19-7/8"	14-3/8"	10"	JM6DCS-1	1
7"	19-7/8"	14-3/8"	11"	JM7DCS-1	1
8"	19-7/8"	14-3/8"	12"	JM8DCS-1	1

- The Adapter Plate (AP) is intended for use with a masonry fireplace with chimney models JM or ALT.
- May also be used with specific factory-built fireplaces listed to UL 127 or CAN/ULC-S610.

Size	A	B	Product Code	Pack
6"	6"	11-5/8"	JM6AP	1
7"	7"	13"	JM7AP	1
8"	8"	13"	JM8AP	1

CATHEDRAL CEILING SUPPORT BOX

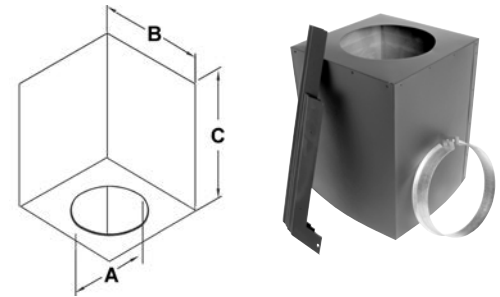

Add JUSI (pg. 16) to the Cathedral Ceiling Support for increased performance and safety.

ROOF SUPPORT

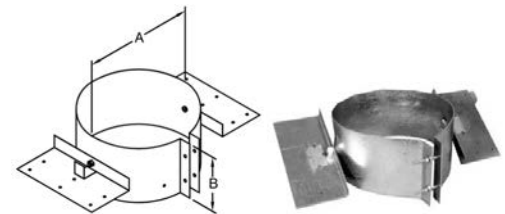

DECORATOR CEILING SUPPORT

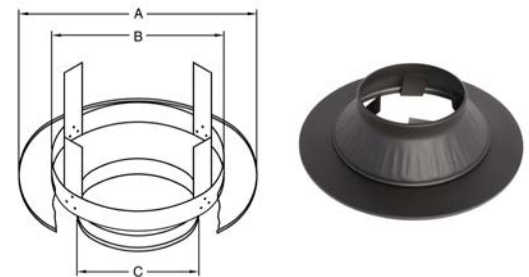

ADAPTER PLATE

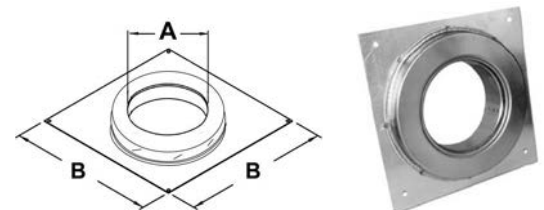

Shields

ADJUSTABLE ATTIC INSULATION SHIELD WITH DROP DOWN

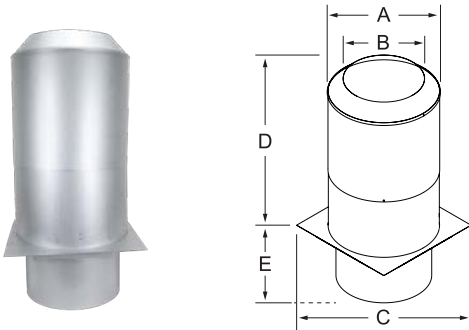

Add JUSI (pg. 16) to the Attic Insulation Shield for increased performance and safety.

- The Adjustable Attic Insulation Shield with Dropdown must be installed where the chimney enters the attic space in any installation.
- Designed to keep insulation away from the chimney and to maintain the mandatory 2" clearance to combustibles.
- Adjustable from 12" to 22".
- Drop down shield protects joist area.

Size	A	B	C	D	E	Product Code	Pack
6"	14"	10-5/16"	16"	12" to 22"	8-1/2"	JM6AAIS	1
7"	15"	11-5/16"	17"	12" to 22"	8-1/2"	JM7AAIS	1
8"	16"	12-5/16"	18"	12" to 22"	8-1/2"	JM8AAIS	1

RAFTER RADIATION SHIELD

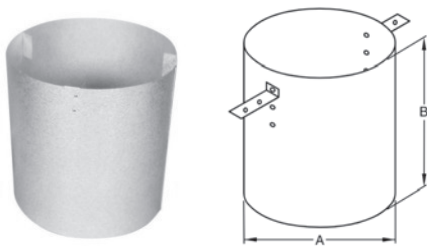

- The RRS must be installed where the chimney is enclosed immediately below the roof line.

Size	A	B	Product Code	Pack
6"	12"	12"	JM6RRS	1
7"	13"	12"	JM7RRS	1
8"	14"	12"	JM8RRS	1

BLACK WALL THIMBLE

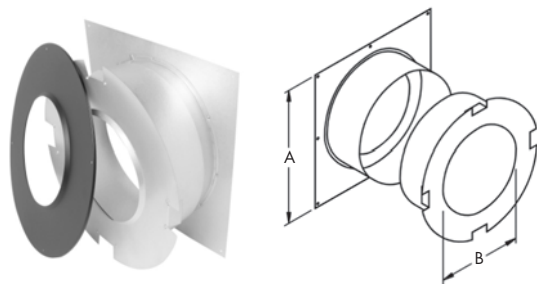

Add JUSI (pg. 16) to the Wall Thimble for increased performance and safety.

- Used in a through-the-wall support installation.
- Radiation shield is included with spacers which maintain the mandatory 2" clearance to combustibles.
- Attractive matte black finishing trim is included.
- Extends to fit 4-1/2" to 8-3/4" wall thickness.

Size	A	B	Product Code	Pack
6"	17"	10-1/8"	JM6WT	1
7"	17"	11-1/8"	JM7WT	1
8"	17"	12-1/8"	JM8WT	1

Shields continued

- Required at all ceiling levels when 45° Elbows are used.
- Serves as a firestop, ensures proper spacing is maintained and provides joist protection.
- Integrated spacers to maintain the mandatory 2" clearance to combustibles.
- Can also be used as an alternate with 15° or 30° elbows when using an Attic Insulation Shield as per instructions.
- The Firestop Spacer must be installed where the chimney passes through the dwelling from one living space to another living space. It is also required when the chimney is enclosed in the attic.

Size	A	B	C	Product Code	Pack
6"	10-5/16"	6"	16"	JM6FS	1
7"	11-5/16"	8"	17"	JM7FS	1
8"	12-5/16"	10"	18"	JM8FS	1

FIRESTOP SPACER - RADIATION JOIST SHIELD

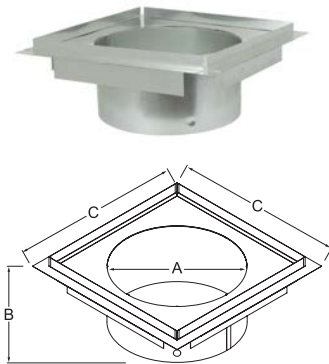

Flashings and Storm Collars

ROOF FLASHING SELECTION CHART

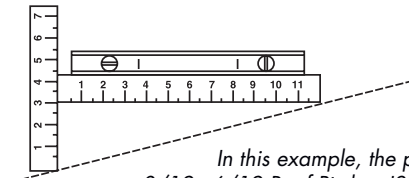

In this example, the pitch is 3/12.
 0/12 - 6/12 Roof Pitch = JSC 6 or 7 AAF
 6/12 - 12/12 Roof Pitch = JSC 6 or 7 AF2

ADJUSTABLE FLASHING ASSEMBLY- FLAT TO 6/12

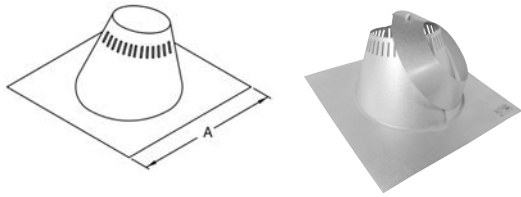

- Used where the chimney passes through a roof with a pitch of 1/12 to 6/12.
- Comes complete with Storm Collar.
- All seams are sealed with Silicone Sealant.
- Galvalume construction.

Size	A	Product Code	Pack
6"	27-1/2" x 27-1/2"	JM6AAF	1
7"	27-1/2" x 27-1/2"	JM7AAF	1
8"	27-1/2" x 27-1/2"	JM8AAF	1
3 Pack			
6"	27-1/2" x 27-1/2"	JM6AAF-3	3
7"	27-1/2" x 27-1/2"	JM7AAF-3	3
8"	27-1/2" x 27-1/2"	JM8AAF-3	3

ADJUSTABLE FLASHING ASSEMBLY- 6/12 TO 12/12

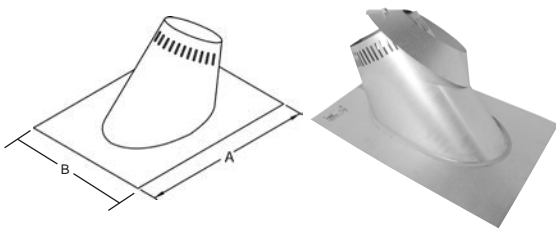

- Used where the chimney passes through a roof with a pitch of 6/12 to 12/12.
- Comes complete with Storm Collar.
- All seams are sealed with Silicone Sealant.
- Galvalume construction.

Size	A	B	Product Code	Pack
6"	30"	21-1/2"	JM6AF2	1
7"	30"	21-1/2"	JM7AF2	1
8"	30"	21-1/2"	JM8AF2	1
3 Pack				
6"	30"	21-1/2"	JM6AF2-3	3
7"	30"	21-1/2"	JM7AF2-3	3
8"	30"	21-1/2"	JM8AF2-3	3

TALL CONE FLASHING

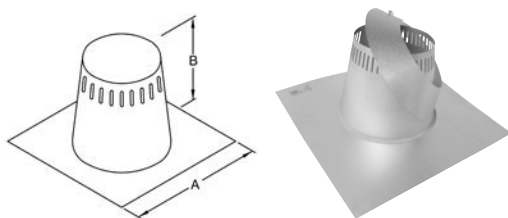

- Used on flat roof surfaces.
- Comes complete with Storm Collar.
- All seams are sealed with Silicone Sealant.

Size	A	B	Product Code	Pack
6"	27"	12"	JM6ATC	1
7"	27"	12"	JM7ATC	1
8"	27"	12"	JM8ATC	1

Flashings and Storm Collars *continued*

- Required where the chimney passes through a peaked roof with a pitch of 3/12 to 6/12.
- Comes complete with Storm Collar.
- Seams are sealed with Silicone Sealant.
- Galvalume construction.

Size	A	B	Product Code	Pack
6"	24"	10"	JM6P1	1
7"	24"	10"	JM7P1	1
8"	24"	10"	JM8P1	1

- Required where the chimney passes through a peaked roof with a pitch of 6/12 to 9/12.
- Comes complete with Storm Collar.
- Seams are sealed with Silicone Sealant.
- Galvalume construction.

Size	A	B	Product Code	Pack
6"	21-1/2"	11-1/2"	JM6P2	1
7"	21-1/2"	12"	JM7P2	1
8"	21-1/2"	11-1/2"	JM8P2	1

- This kit fits 6", 7" and 8" Chimneys.
- Required where the chimney passes through a corrugated roof.
- Rubber Boot Flashing fits roof pitches up to 10/12 for 6", 9/12 for 7" and 8/12 for 8".

Size	Product Code	Pack
ALL	JURBFK2	1

- Used in conjunction with Roof Flashing to keep precipitation out.

Size	A	B	Product Code	Pack
6"	10"	5-1/2"	JM6ASC-1	1
7"	11"	5-1/2"	JM7ASC-1	1
8"	12"	5-1/2"	JM8ASC-1	1

- Used to seal Storm Collar to chimney length above cone of flashing.
- 3 ounce tubes.

Size	Product Code	Pack
1 tube	JRTV	1

PEAK FLASHING - 3/12 TO 6/12

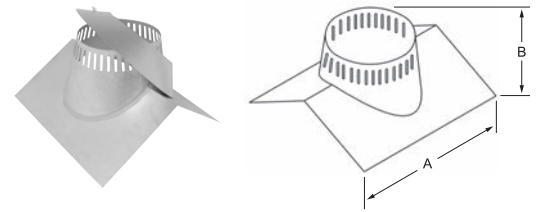

PEAK FLASHING - 6/12 TO 9/12

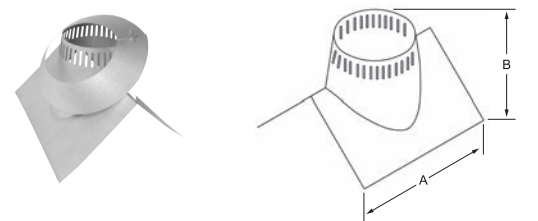

RUBBER BOOT FLASHING KIT



- THIS KIT INCLUDES:**
- Special Storm Collar
 - Rubber Boot.
 - Spacer Kit.
 - Special Boot Mounting Screws

ALUMINUM STORM COLLAR

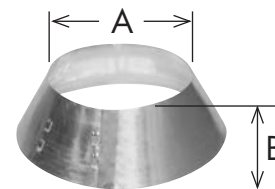

SILICONE SEALANT FOR STORM COLLAR



Rain Caps

STANDARD RAIN CAP

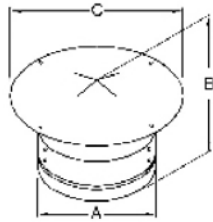

- Designed to allow free flow of air and used in conjunction with spark arrestor (included) to prevent access to flue by foreign objects.

Size	A	B	C	Product Code	Pack
6"	10"	7-1/2"	12-1/4"	JM6RC	1
7"	11"	7-1/2"	13-1/4"	JM7RC	1
8"	12"	7-1/2"	14-1/4"	JM8RC	1

DELUXE RAIN CAP

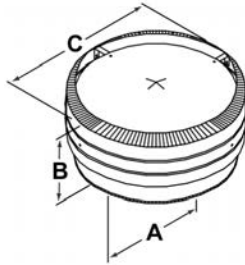

- Advanced design.
- Provides protection against precipitation and creates a venturi effect to enhance draught.
- Twist-lock connection for secure installation.

Size	A	B	C	Product Code	Pack
6"	10"	7-1/2"	13-1/4"	JM6DRC	1
7"	11"	7-1/2"	14-1/4"	JM7DRC	1
8"	12"	7-1/2"	17-1/4"	JM8DRC	1

SPARK ARRESTOR

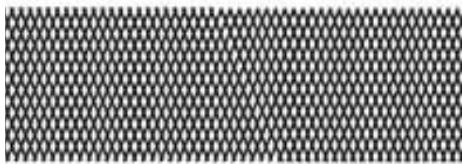

- Stainless steel mesh wire fits inside Deluxe Rain Cap.

Size	Dimensions	Product Code	Pack
6"	4-1/2" x 26"	JSC6SPAR	10
7"	4-1/2" x 29"	JSC7SPAR	10
8"	4-1/2" x 32"	JSC8SPAR	10

Parts and Accessories

- Stainless steel construction.
- Provides lateral support for the chimney when installed adjacent to a wall.
- Maintains the mandatory 2" clearance to combustibles.
- Install midway on the first length above the Tee, then every 8 feet thereafter.

Size	A	B	Product Code	Pack
5"	10"	17"	JM6WB	1
6"	11"	17"	JM7WB	1
7"	12"	17"	JM8WB	1

- Quick and easy transition from black stove pipe or Double Wall Black Stove Pipe to factory-built chimney.
- Twist-lock for easy connection.
- Stainless Steel.

Size	A	B	C	Product Code	Pack
6"	10"	6"	5-5/8"	JM6ASE	1
7"	11"	7"	5-5/8"	JM7ASE	1
8"	12"	8"	5-5/8"	JM8ASE	1

- Used where the chimney passes through a soffit to provide a finished appearance.
- Maintains the mandatory 2" clearance to combustibles.

Size	A	B	Product Code	Pack
6"	10-3/16"	16"	JM6FP	1
7"	11-3/16"	17"	JM7FP	1
8"	12-3/16"	18"	JM8FP	1

- Used when 5 feet or more of chimney extends above the roof.
- The kit includes two 4 foot rods and an adjustable band.
- Each rod extends to approximately 7-1/2 feet.
- The adjustable band will fit 6", 7" and 8" diameter chimney.

Size	A	B	Product Code	Pack
6"	10" - 13"	4' - 7-1/2'	JURGK-1	1
7"	10" - 13"	4' - 7-1/2'	JURGK-1	1
8"	10" - 13"	4' - 7-1/2'	JURGK-1	1

WALL BAND

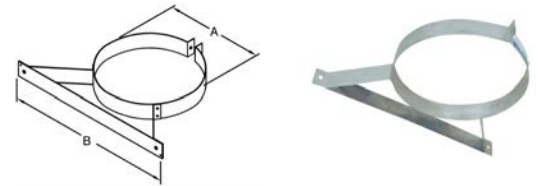

BLACK STOVE PIPE ADAPTER

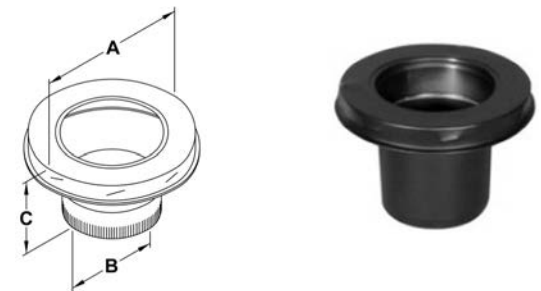

FINISHING PLATE

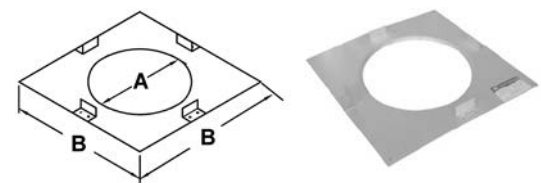

UNIVERSAL ROOF GUY KIT

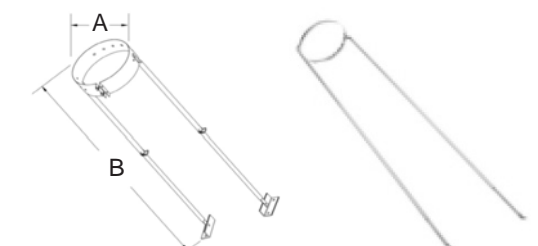

JUSI-UNIVERSAL SHIELDING INSULATION

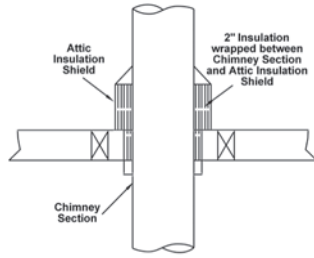

- Insulation for use with:
 - Attic Insulation Shield (JM*AAIS).
 - Wall Thimble (JM*WT).
 - Cathedral Ceiling Support (JM*CCSB).
- Reduces cold air infiltration into the dwelling.
- Provides additional protection against heat from the chimney.

Size	Product Code	Pack
Universal	JUSI	1

MASONRY ADAPTER KIT

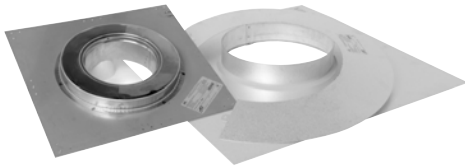

- Kit includes Anchor Plate, Masonry Flashing and Storm Collar.
- Used to extend the height of a masonry chimney using SuperVent 2100 chimney.
- Available in 6", 7", and 8" diameters.

Size	Product Code	Pack
6"	JM6MAK	1
7"	JM7MAK	1
8"	JM8MAK	1

Support Kits

SuperVent 2100 has put together 3 chimney kits to get your project done . . .

We often hear "Kits don't work" from our Hearth customers!

. . . Here is the strategy behind our SuperVent 2100 Kits - and why they make sense for you.

- A Kit is available for each of the 3 main methods of supporting a chimney system.
- Each Kit **ONLY** includes the parts that are used in the majority of every installation.
- Kits do **NOT** include any parts that may vary in different applications, such as Roof Flashings, Chimney Lengths, etc.

Simply decide which of these scenarios fits your need, then pick up your chimney lengths, roof flashing and elbows (if required).

When your chimney goes up through a flat ceiling, attic space, then thru the roof, you may choose the MODEL SuperVent 2100 DECORATOR CEILING SUPPORT INSTALLATION KIT - JM*DCSP-N.

- Deluxe Rain Cap
- Adjustable Attic Insulation Shield with Dropdown
- Decorator Ceiling Support
- Stove Pipe Adaptor

NOTE: In a two story application, purchase the Ceiling Support Installation Kit (DCSP-N) and install a Firestop Spacer at the ceiling level to provide proper fire stopping.

. . . Now you just need your roof flashing and chimney lengths.

CEILING SUPPORT KIT

Size	Product Code
6"	JM6DCSP-N
7"	JM7DCSP-N



When your chimney goes out a cathedral or open beam ceiling, you may choose the MODEL SuperVent 2100 CATHEDRAL CEILING SUPPORT INSTALLATION KIT - JM*CCSK.

- Deluxe Rain Cap
- Cathedral Ceiling Support
- Draw Band
- Trim Kit
- Stove Pipe Adaptor

...Now you just need your roof flashing and chimney lengths.

CATHEDRAL CEILING SUPPORT KIT

Size	Product Code
6"	JM6CCSK
7"	JM7CCSK



When your chimney goes out a wall and then runs straight up, you'll need the MODEL SuperVent 2100 WALL SUPPORT INSTALLATION KIT - JM*WSP.

- Deluxe Rain Cap
- Wall Bands (2)
- Stove Pipe Adaptor
- Wall Thimble
- Stainless Steel Tee with Plug
- Adjustable Wall Support

...Now you just need:

- Vertical Chimney lengths
- Through the wall length (must extend at least 3" into the room)
- 12" chimney length or insulated tee plug (installed below the wall support)

WALL SUPPORT KIT

Size	Product Code
6"	JM6WSP
7"	JM7WSP





For training, detailed product information, downloadable catalogs and installation instructions visit our website:

selkirkcorp.ca



Selkirk Canada Corporation

950 South Service Road

Second Floor

Stoney Creek, ON L8E 6A2

phone: 1.888.SELKIRK (735.5475)

email: cscanada@selkirkcorp.com

Complete Linecard



residential chimney



roof curbs & equipment rails



access doors



rooftop products



residential vent



duct components



grilles, registers, diffusers



commercial industrial vent